

## DOCUMENT RESUME

ED 402 702

EC 305 210

AUTHOR Kenny, David A.; And Others  
 TITLE The Effects of Group Composition on Gifted and Non-Gifted Elementary Students in Cooperative Learning Groups.  
 INSTITUTION National Research Center on the Gifted and Talented, Storrs, CT.  
 SPONS AGENCY Office of Educational Research and Improvement (ED), Washington, DC.  
 REPORT NO RM-95116  
 PUB DATE Sep 95  
 CONTRACT R206R00001  
 NOTE 162p.  
 AVAILABLE FROM NRC/GT, University of Connecticut, 362 Fairfield Road, U-7, Storrs, CT 06269-2007.  
 PUB TYPE Reports - Research/Technical (143) -- Tests/Evaluation Instruments (160)

EDRS PRICE MF01/PC07 Plus Postage.  
 DESCRIPTORS \*Academic Achievement; \*Cooperative Learning; Elementary School Students; \*Gifted; Grade 4; Grouping (Instructional Purposes); \*Heterogeneous Grouping; \*Homogeneous Grouping; Instructional Effectiveness; Intermediate Grades; Peer Relationship; Self Concept; Self Esteem; Social Influences; \*Student Attitudes

## ABSTRACT

A study of 786 fourth-grade students (229 gifted and 557 nongifted) assessed the effects of both heterogeneous and homogeneous grouping in cooperative learning settings on the performance of gifted and nongifted students. Results found that gifted fourth-grade students experienced no adverse effects as a result of interacting with nongifted students in cooperative learning groups. The gifted students did not learn less, experience a decline in self-concept, or become less popular with peers. Gifted students were seen as more friendly and better leaders, and they experienced a relative increase in social self-esteem in heterogeneous groups. The nongifted students did not experience an increase in achievement due to the presence of a gifted student. Nongifted students in heterogeneous groups suffered from a decline in self-esteem and a decline in perception by nongifted peers on task-relevant activities. In sum, the heterogeneous grouping was found to have positive socioemotional outcomes for the gifted students and negative ones for nongifted students. Appendices include mathematics and science achievement tests, a self-perception test, a student attitude questionnaire, a content area preference scale, and mathematics curriculum worksheets. (Contains over 100 references.) (Author/CR)

\*\*\*\*\*  
 \* Reproductions supplied by EDRS are the best that can be made \*  
 \* from the original document. \*  
 \*\*\*\*\*

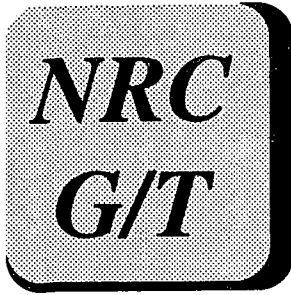

**THE NATIONAL  
RESEARCH CENTER  
ON THE GIFTED  
AND TALENTED**



*The University of Connecticut  
The University of Georgia  
The University of Virginia  
Yale University*

The Effects of Group Composition  
on Gifted and Non-Gifted  
Elementary Students in Cooperative  
Learning Groups

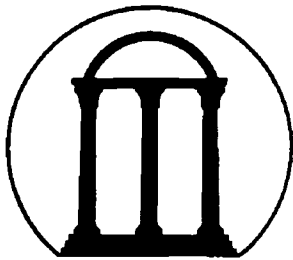

**1785**  
The University of Georgia

David A. Kenny  
Francis X. Archambault, Jr.  
Bryan W. Hallmark



U.S. DEPARTMENT OF EDUCATION  
Office of Educational Research and Improvement  
EDUCATIONAL RESOURCES INFORMATION  
CENTER (ERIC)

This document has been reproduced as  
received from the person or organization  
originating it.  
 Minor changes have been made to  
improve reproduction quality.

• Points of view or opinions stated in this  
document do not necessarily represent  
official OERI position or policy.

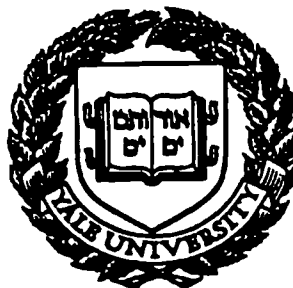

The University of Connecticut  
Storrs, Connecticut

September 1995  
Research Monograph 95116

EC305210

# **The Effects of Group Composition on Gifted and Non-Gifted Elementary Students in Cooperative Learning Groups**

David A. Kenny  
Francis X. Archambault, Jr.  
Bryan W. Hallmark

The University of Connecticut  
Storrs, Connecticut

September 1995  
Research Monograph 95116

# **THE NATIONAL RESEARCH CENTER ON THE GIFTED AND TALENTED**

---

The National Research Center on the Gifted and Talented (NRC/GT) is funded under the Jacob K. Javits Gifted and Talented Students Education Act, Office of Educational Research and Improvement, United States Department of Education.

The Directorate of the NRC/GT serves as the administrative unit and is located at The University of Connecticut.

The participating universities include The University of Georgia, The University of Virginia, and Yale University, as well as a research unit at The University of Connecticut.

The University of Connecticut  
Dr. Joseph S. Renzulli, Director  
Dr. E. Jean Gubbins, Assistant Director

The University of Connecticut  
Dr. Francis X. Archambault, Associate Director

The University of Georgia  
Dr. Mary M. Frasier, Associate Director

The University of Virginia  
Dr. Carolyn M. Callahan, Associate Director

Yale University  
Dr. Robert J. Sternberg, Associate Director

Copies of this report are available from:

NRC/GT  
The University of Connecticut  
362 Fairfield Road, U-7  
Storrs, CT 06269-2007

Research for this report was supported under the Javits Act Program (Grant No. R206R00001) as administered by the Office of Educational Research and Improvement, U.S. Department of Education. Grantees undertaking such projects are encouraged to express freely their professional judgement. This report, therefore, does not necessarily represent positions or policies of the Government, and no official endorsement should be inferred.

---

## **Note to Readers...**

All papers by The National Research Center on the Gifted and Talented may be reproduced in their entirety or in sections. All reproductions, whether in part or whole, should include the following statement:

**Research for this report was supported under the Javits Act Program (Grant No. R206R00001) as administered by the Office of Educational Research and Improvement, U.S. Department of Education. Grantees undertaking such projects are encouraged to express freely their professional judgement. This report, therefore, does not necessarily represent positions or policies of the Government, and no official endorsement should be inferred.**

**This document has been reproduced with the permission of The National Research Center on the Gifted and Talented.**

If sections of the papers are printed in other publications, please forward a copy to:

The National Research Center on the Gifted and Talented  
The University of Connecticut  
362 Fairfield Road, U-7  
Storrs, CT 06269-2007

---

## Acknowledgements

The field research described in this report was a large, complex study involving students, teachers, and administrators from eight school districts in various parts of the country and a team of researchers at The National Research Center on the Gifted and Talented (NRC/GT). Given the size and complexity of this research, its successful completion required the cooperation and active involvement of numerous individuals. We would like to thank each of them for their support, assistance, and participation.

First and foremost, we thank Joseph S. Renzulli, Director of The National Research Center on the Gifted and Talented, for his unflagging commitment to this project from its conceptualization to its conclusion. We thank Sally Reis, Karen Westberg, and E. Jean Gubbins for their help in curriculum design, for their assistance in soliciting cooperation from Collaborative School Districts, and for their innumerable and insightful suggestions at all stages of the study. We thank Del Siegle and Tom Hays for serving as experimenters in this research, and, along with Tom Hébert, for helping create the curriculum we used. We thank Stuart Omdal, Dawn Guenther, Dee Korner, and Marion Lapierre for their logistical support and for generally ensuring that "the train ran on time." And we offer a special thank you to Jann Leppien who, in addition to helping create the curriculum and serving as an experimenter, made an extraordinary effort to make this project a success.

In addition to the NRC/GT team, we would also like to thank Michele Sorenson, Toni Paige, and Debra Hardick, who served as experimenters, the teachers who allowed us to implement the study in their classrooms, the students and their parents who eagerly supported our efforts and provided the data, the gifted and talented coordinators and other administrators in the eight districts who made the difficult job of scheduling experiment days and times easy, and the superintendents, principals, and other district personnel who allowed us in their schools. We also thank the external reviewers of an earlier version of this document for their helpful comments and suggestions as well as Wanli Zhang and David Tetrault for their expert help in data analysis. Finally, we thank Virginia Carrow and Cynthia Mohr for their help in preparing and editing the final copy of this report.

# **The Effects of Group Composition on Gifted and Non-Gifted Elementary Students in Cooperative Learning Groups**

David A. Kenny  
Francis X. Archambault, Jr.  
Bryan W. Hallmark

University of Connecticut  
Storrs, Connecticut

## **ABSTRACT**

This research was undertaken to provide researchers, administrators, and teachers with tangible evidence as to the effectiveness of cooperative learning with gifted students. A controlled field experiment was designed to assess the effects of both heterogeneous and homogeneous grouping in cooperative learning settings on the performance of gifted and non-gifted students, including their achievement, self-concept, and attitude toward school subjects, as well as the feelings that they have toward one another. It was also designed to determine whether different types of cooperative learning arrangements implemented in different content areas yield comparable results. The study involved 786 fourth grade students drawn from 42 classrooms located in 8 school districts.

Gifted fourth grade students experienced no adverse effects as a result of interacting with non-gifted students in cooperative learning groups. The gifted student does not learn less, experience a decline in self-concept, or become less popular in his or her group. In fact, students are seen as more friendly and better leaders in these groups, and they experience a relative increase in social self-esteem in heterogeneous groups.

At the same time, the non-gifted student does not experience an increase in achievement due to the presence of a gifted student. Thus, the view of the gifted child as a teaching resource was not supported. However, the non-gifted student in heterogeneous groups suffers from a decline in self-esteem and a decline in the perception by non-gifted peers on task-relevant activities. In sum, heterogeneous grouping has positive socioemotional outcomes for gifted children and negative ones for non-gifted children.

# The Effects of Group Composition on Gifted and Non-Gifted Elementary Students in Cooperative Learning Groups

David A. Kenny  
Francis X. Archambault, Jr.  
Bryan W. Hallmark

University of Connecticut  
Storrs, Connecticut

## EXECUTIVE SUMMARY

### Introduction

Cooperative learning refers to the use of non-competitive learning groups in the classroom. It has gained widespread acceptance in educational circles over the past decade. Slavin (1991) reported that whereas few teachers regularly used cooperative methods in the early 1980s, hundreds of thousands were routinely using cooperative learning strategies by the early 1990s. Numerous studies have shown that cooperative learning positively affects student achievement and self-esteem. Cooperative learning also positively affects the way children relate to one another, particularly children from different ethnic and economic backgrounds.

Despite these positive outcomes, a number of observers (e.g., Robinson, 1991; Rogers, 1991) have questioned the appropriateness of cooperative learning for gifted children. Their concern stems in large part from the almost universal use of heterogeneous ability grouping in cooperative learning arrangements, a practice which critics claim helps the non-gifted but harms the gifted (Kulik, 1992). This criticism also stems from the paucity of research evidence supporting the use of cooperative learning with this special population. In a recent review of the literature, Robinson uncovered 301 ERIC references and 204 PSYCHINFO references on cooperative learning for the period 1967 through 1991, but only three of these references reported original research on the effect of cooperative learning on the gifted and each of these involved fewer than 50 gifted students. Robinson also reported that very few studies of cooperative learning have been undertaken with high ability students, that the studies which did inquire into the effects of cooperative learning on the gifted often used inappropriate definitions of giftedness, and that the studies used weak treatment comparisons. The studies compared cooperative learning against traditional classrooms rather than treatments more suited to academically talented students. Thus, Robinson concluded that administrators and teachers using cooperative learning students are over-generalizing from the available research evidence.

This research was undertaken to provide researchers, administrators, and teachers with tangible evidence as to the effectiveness of cooperative learning with gifted students. A controlled field experiment was designed to assess the effects of both heterogeneous and homogeneous grouping in cooperative learning settings on the performance of gifted and non-gifted students, including their achievement, self-concept, and attitude toward school subjects, as well as the feelings that they have toward one another. It was also designed to determine whether different types of cooperative learning arrangements implemented in different content areas yield comparable results. The study involved 786 fourth grade students drawn from 42 classrooms located in 8 school districts. To our knowledge, this is the largest study to date on cooperative learning and the gifted.



## Research Questions

This study investigated the effects of cooperative learning strategies implemented in homogeneous and heterogeneous ability groups on gifted and non-gifted students' achievement, self-concept, attitudes toward school subjects, and perceptions of peers. The major research questions are as follows:

### *Achievement*

- Do gifted students learn more in homogeneous groups than they learn in heterogeneous groups?
- Do non-gifted students learn the same in homogeneous and heterogeneous groups?
- Does having a gifted student in a group improve the performance of others in the group?

### *Self-concept*

- Do gifted students have more positive self-concepts than non-gifted students?
- When there is a gifted student in the group, does students' self-esteem decline?
- Does homogeneous or heterogeneous grouping lead to changes in self-esteem?

### *Attitude Toward School Subjects*

- Does cooperative learning lead to more positive attitudes for gifted versus non-gifted students?
- Does interacting with gifted or non-gifted students lead to more positive attitudes toward school subjects?
- Does homogeneous versus heterogeneous grouping have an effect on school attitudes?

### *Perception of Peers*

- Are gifted students perceived by their peers more positively or negatively?
- Are gifted students perceived by their peers as providing more help than non-gifted students to other members of the cooperative learning groups?
- Do non-gifted students have more negative perceptions of each other when they are in heterogeneous groups than when they are in homogeneous groups?

## Method

### Sample

A total of 786 students from 8 school districts participated in the study of which 29% were classified as gifted. Of course, gifted students were oversampled in this study, and so it is not typical to find that 29% of the students in a classroom are gifted.

A total of 414 females and 372 males participated in this study. The sample is predominantly White, but there are about 13% non-Whites in both the gifted and non-gifted groups. About 50% of the non-White group were African Americans.

### Design

Within each classroom three different types of groups were formed. Groups were all gifted (homogeneous gifted), all non-gifted (homogeneous non-gifted), and mixed (one gifted and two non-gifted). Children were randomly assigned to either heterogeneous or homogeneous groups.

## Curriculum

Two sets of curriculum materials were developed for this study: a mathematics curriculum and a science curriculum. The mathematics curriculum was concerned with measuring the perimeter and calculating the area of objects. The science curriculum was concerned with electricity.

The mathematics curriculum was a basic-skills, worksheet-based instructional unit which included twenty-three worksheets organized in increasing levels of difficulty. For example, the first worksheet had groups measure the lengths of lines, the thirteenth worksheet asked students to estimate the area of a square, and the twenty-third worksheet asked students to measure the area of circular objects. Although the worksheets progressively became more difficult, to maintain the basic-skills nature of the task, some material from earlier worksheets was reported on later worksheets. The mathematics curriculum is thus similar to Student Teams Achievement Division (STAD) developed by Slavin (1990).

The mathematics curriculum was designed to minimize instructor contact with students and maximize group interaction. This was accomplished in several ways: (1) by limiting instructor introduction to the topic of perimeter and area to 10 minutes on the first day of instruction; (2) by ensuring that all subsequent instructions to complete the worksheets were given to groups in the form of instructional sheets; and (3) by allowing all groups to work at their own pace. Once a group completed a worksheet, the members were able to correct the worksheet, and continue to the next worksheet.

The science curriculum was a more creative, idea-generating task. It contained three separate worksheets which covered four areas of electricity: static electricity, current electricity, conductors and insulators, and electromagnets. On each day of instruction, groups received a brief, five-minute introduction to one of the four topic areas and a worksheet which contained all the information necessary to complete experiments and to answer questions regarding the results of these experiments.

## Measures

The impact of the cooperative learning treatment was assessed using measures of achievement, self-concept, attitude toward school subjects, and peer relations. Each will be described in turn.

### Achievement

Two achievement tests were constructed to assess the effect of the cooperative learning experience on students, one for the mathematics curriculum and one for science curriculum. The mathematics measure contained 21 items covering the measurement of area and perimeter. Each item answered correctly was worth one point, for a total of 21 possible points.

The science achievement test contained 17 items. The items assessed knowledge of static electricity, current electricity, and electromagnets. Both the science and mathematics measures were constructed so that most students would not be able to obtain the maximum possible points. In the pilot of the materials, no student obtained a perfect score on either measure.

## Self-Concept

A modified version of the Harter *Self-Perception Profile for Children (SPPC)*; Harter, 1985) was used to measure students' self-concept. This instrument, which is designed to assess elementary-aged children's self-concepts, has a total of six self-concept subscales, only three of which were used in the present research.

The three subscales used were global self-concept, academic self-concept, and social self-concept. The global self-concept scale provides a measure of how children feel about their lives in general; for example, do they feel important. The academic self-concept scale measures whether children feel that they do well in school, for example, do they feel that they are doing well in school or are other people doing better. The social self-concept scale measures whether children feel they are popular. These three subscales were selected because they were the most pertinent subscales for purposes of this study. The same version of the scale was administered prior to treatment and after treatment.

## The Content Area Preference Scale (CAPS)

The *Content Area Preference Scale* was developed to measure student preference toward subjects such as mathematics and science (Kulikowich, 1990). The CAPS consists of 3-point Likert items where students circle either a happy face (I agree with the statement), an uncertain face (I neither agree nor disagree with the statement), or a sad face (I disagree with the statement). There are four science items and four mathematics items.

## Peer Relations

Peer relations was assessed through the *Student Attitudes Questionnaire (SAQ)*, which was designed expressly for the present study. This instrument asked each person in each three-person group to rate the other two group members with regard to eight characteristics on the pretest and ten characteristics on the posttest using a four-point scale. Pretest characteristics included the following:

- How well they *know* the student;
- How *friendly* the student is;
- How good a *teammate* the student is;
- How *smart* the student is;
- How much they *like* the student;
- How much they *play* with the student after school;
- How *shy* the student is;
- What kind of a *leader* the student is.

For the posttest, we no longer asked how well they knew the other students in the group, but we added three other characteristics:

- How much *help* the student provided;
- How much they *helped* the other students;
- How much they would like to be in *another group* with the student.

## Analysis

The unit of analysis is classroom. From each classroom four different means were computed: homogeneous gifted, homogeneous non-gifted, gifted student from a heterogeneous group, and non-gifted student from a heterogeneous group. Using a model, three effects were used to estimate the following: a) Do gifted students learn more than

non-gifted children? b) Do students learn more when there are more non-gifted students in the group? c) Do students learn more in heterogeneous versus homogeneous groups?

## Results

As noted above, this study investigated the effects of cooperative learning strategies implemented in homogeneous and heterogeneous ability groups on gifted and non-gifted students' achievement, self-concept, attitudes toward school subjects, and perceptions of peers. The major findings for each of these outcome measures are as follows:

### *Achievement*

1. The achievement of gifted students exceeded that of non-gifted students in both mathematics and science regardless of the type of group in which they were involved, but this difference can be entirely explained by the gifted students' higher prior achievement.
2. Gifted students worked at a quicker pace and produced more when grouped with other gifted students. Said in another way, the productivity level of the group is directly tied to the number of gifted students in the group.
3. However, gifted students learned about the same (i.e., had the same levels of posttest achievement) in homogeneous gifted groups as they did in heterogeneous groups.
4. Non-gifted students learned the same in homogeneous and heterogeneous groups.
5. Having a gifted student in a group does not significantly improve the performance of others in the group.

### *Self-concept*

6. Gifted students saw themselves as smarter than their non-gifted peers prior to the treatment (i.e., their academic self-esteem is higher).
7. Gifted students had a higher perception of their worth as a person (global self-esteem) than non-gifted students prior to the treatment.
8. Gifted and non-gifted students' social self-esteem did not differ prior to the treatment.
9. Both the gifted and non-gifted students' social self-esteem declined when they were in a group with another gifted student.
10. Academic self-esteem improved for both gifted and non-gifted students, but more for non-gifted students.
11. Neither gifted nor non-gifted students' global self-esteem was affected by the cooperative learning arrangement.
12. There were no differences in the three self-esteem measures (i.e., global, social, and academic) for heterogeneously grouped gifted students versus homogeneously grouped students.

### *Attitude Toward School Subjects*

13. The different grouping strategies have no significant effect on the attitudes toward mathematics and science of either gifted or non-gifted students.

### *Perception of Peers*

14. Gifted students are perceived by their peers as more intelligent, better teammates, and as more likely to leaders than non-gifted students. The relatively favorable impressions of the gifted students remained after the grouping experience.
15. At the end of the study, gifted and non-gifted students had more negative impressions of each other than they had before the treatment began.

16. Gifted students were perceived by their peers as providing more help than non-gifted students to other members of the cooperative learning groups.
17. Non-gifted students had more negative perceptions of each other when they were in heterogeneous groups than when they were in homogeneous groups.

How do students with different academic abilities affect other students in cooperative learning groups? Our research suggests that heterogeneous and homogeneous ability grouping in comparative learning contexts has no appreciable effects on students' academic outcomes. It also suggests that having a high ability student in a group does not help other students to learn more. Gifted students are perceived by other group members to be more helpful than non-gifted students. However, if gifted students are helping students, this help does not translate into greater academic gains for the gifted students' teammates.

If grouping does not affect the academic outcomes of students, choices regarding how to group students should be based on considerations other than improving academic growth. If the goal of grouping is promoting students' sense of self-worth, then teachers should realize that mixed ability grouping can have a negative effect on average ability students' self-concept. Even though we found few changes in student self-concept that attributed to the composition of the groups, when any student works with a gifted student, the social self-concept of gifted student's teammate declines.

Another reason for grouping students is to have students learn to cooperate with each other and in turn improve the social relationships among students, that is, have students "learn to get along." The current findings suggest that the group interaction process may not achieve this goal. In fact, we found that overall students' interpersonal perceptions were more negative following group interaction. We also found that gifted students affect non-gifted students' perceptions of each other. In the presence of a gifted student, non-gifted students perceive that their non-gifted peers are not as smart, less helpful, and less likely to be a leader than if there are no gifted students in the group. Thus, if cooperative learning with heterogeneous grouping is to occur, teachers will need to explain to students that some students will need to help other students more and that if they do they are just doing their job.

It appears that the majority of changes in the interpersonal perceptions involved traits related to classroom behavior. It seems that the group experience led to agreement that some members were skilled in dimensions more closely associated with classroom activities, e.g., leadership, teammate, and smart. However, there was no agreement on dimensions related to socioemotional dimensions, such as friendliness and liking. It may be that in academic-oriented tasks students do not have the opportunity to display behavior related to socioemotional dimensions. To promote friendship and liking in a group may require group tasks to be less academically oriented, and more oriented towards promoting friendship.

## Conclusions

Before reviewing the major conclusions of the study, it is important to realize certain limitations of the study. Several features of this study could explain the lack of significant findings for the achievement outcomes. If the treatment period had been longer than 7 1/2 hours, more statistically significant effects may have been found.

This study also avoided any intergroup competition which most models of cooperative learning advocate. Although it is presumed that intergroup competition

improves student achievement, intergroup competition was avoided in the present study because of the concern that a homogeneous gifted group would do better than all other groups, and this could have had a negative effect on all students in the classroom.

Finally, several features of the study limit the generalizability of the results. First, the racial/ethnic composition of the study sample (approximately 87% White) limits the degree to which these results can be generalized to all students in the United States. Second, the tasks used in this study were specifically designed for the purposes of this research. That is, they were designed with specific time limits in mind and to promote group interaction. Thus, the nature of the curriculum also limits the generalizability of the findings. Third, the students involved in this research may be too young to be able to successfully help one another. If so, the results of this study may not be generalizable to older, more capable students.

With these limitations in mind, an important question this study has answered is: What happens to gifted and non-gifted children when they interact together in cooperative learning groups? Gifted fourth grade students experienced no adverse effects as a result of interacting with non-gifted students in cooperative learning groups. The gifted student does not learn less, experience a decline in self-concept, or become less popular in his or her group. In fact, gifted students are seen as more friendly and better leaders in these groups, and they experience a relative increase in social self-esteem in heterogeneous groups.

At the same time, the non-gifted student does not experience an increase in achievement due to the presence of a gifted student. Thus, the view of the gifted student as a teaching resource was not supported. However, the non-gifted student in heterogeneous groups suffers decline in self-esteem and a decline in the perception by non-gifted peers on task-relevant activities. In sum, heterogeneous grouping has positive socioemotional outcomes for gifted students and negative ones for non-gifted students.

The view that the gifted student serves as a resource does receive some support in this study. Gifted students were seen as providing help and leadership in groups. However, this did not translate into greater learning for the gifted student's peers.

Finally, claims that homogeneous grouping of gifted students leads to synergetic benefits for these students was not supported. There is no evidence in this study that grouping gifted students homogeneously in cooperative groups is any more beneficial educationally than heterogeneous grouping. However, because the curriculum was not modified for these groups, we do not know how they would have performed with a more accelerated curriculum.

## References

- Harter, S. (1985). *Manual for the Self-Perception Profile for Children*. Unpublished manuscript, University of Denver.
- Kulik, J. A. (1992). *An analysis of the research on ability grouping: Historical and contemporary approaches* (RBDM 9204). Storrs, CT: University of Connecticut, The National Research Center on the Gifted and Talented.
- Kulikowich, J. M. (1990). *The Content Area Preference Scales (CAPS)*. Storrs, CT: University of Connecticut, The National Research Center on the Gifted and Talented.
- Robinson, A. (1991). *Cooperative learning and the academically talented student* (RBDM 9106). Storrs, CT: University of Connecticut, The National Research Center on the Gifted and Talented.
- Rogers, K. B. (1991). *The relationship of grouping practices to the education of the gifted and talented learner* (RBDM 9102). Storrs, CT: University of Connecticut, The National Research Center on the Gifted and Talented.
- Slavin, R. E. (1990). *Cooperative learning: Theory, research, and practice*. Englewood Cliffs, NJ: Prentice-Hall.
- Slavin, R. E. (1991). Synthesis of research on cooperative learning. *Educational Leadership*, 48(5) 71-82.

## Table of Contents

<b>ABSTRACT</b>	vii
<b>EXECUTIVE SUMMARY</b>	ix
<b>CHAPTER 1: Introduction and Review of Related Literature</b>	1
Cooperative Learning	2
Effects on Achievement	2
Effects on Self-Esteem and Interpersonal Relations	4
Effects on Students' Liking of Class	4
Effects on Liking and Being Liked by Classmates	5
Cooperative Learning, Ability Grouping, and Gifted Students	5
Ability Grouping and the Achievement of Gifted Students	7
Ability Grouping and the Self-Concept of Gifted Students	10
Self-Concept of Gifted Students	10
Self-Concept of Gifted Students in Group Settings	11
<b>CHAPTER 2: Methods</b>	13
Sample	13
Classroom Selection	13
Group Assignment	14
Measures	14
Achievement	14
Self-Concept	16
Peer Relations	16
The Content Area Preference Scale	17
Curriculum Materials	17
Procedures	18
General Protocol	25
Pilot of Procedures, Curriculum, and Instruments	25
<b>CHAPTER 3: Design and Analysis Issues</b>	27
The Basic Analysis Model	27
Individual-Level Measures	27
Dyadic-Level Measures	31
Variance Partitioning of the Individual-Level Measures	32
Choice of Unit of Analysis	34
Reliability of the Measures	35
Individual-Level Measures	35
Dyadic-Level Measures	35
Control Variables	38
Pretest Measures	38
Prior Achievement	38
Order of the Curriculum	39
Classroom	39
Group	39
Other Variables	39
Missing Data	39
Sources of Missing Data	39
Estimation of Prior Achievement	40



## Table of Contents (continued)

<b>CHAPTER 4: Results for the Individual-Level Measures</b>	41
Descriptive Data for Sample	41
Review of Analysis Model	42
Achievement Results	42
Basic Analysis of Raw Scores	43
Basic Analysis With an Adjustment for Prior Achievement	44
Additional Analyses	45
Number of Worksheets Completed	45
Easy Versus Difficult Items	45
Different Criterion for Giftedness	45
Self-Concept Results	46
Interest in Subject	48
<b>CHAPTER 5: Results for the Dyadic Measures</b>	51
Basic Model and Statistics	51
Pretreatment Ratings	51
Posttreatment Ratings	54
Change Scores	56
Conclusion	57
<b>CHAPTER 6: Summary, Discussion, and Conclusions</b>	59
Review of Major Findings	59
Achievement Findings	60
Self-Concept Findings	61
Interpersonal Perceptions Findings	62
Perceptions Prior to Interaction	63
How Group Members' Perceptions of All Students Changed After Interaction	63
Changes in How Group Members Perceived Gifted Students After Interaction	63
Changes in How Non-Gifted Group Members Perceived Other Non-Gifted Students After Interaction	64
The Picture of Interpersonal Perceptions in the Groups	65
Limitations of the Current Study	65
Conclusion	66
Summary	67
<b>References</b>	69
<b>Appendices</b>	77
Appendix A: Mathematics and Science Achievement Tests	77
Appendix B: Modified Version of the <i>Self-Perception Profile for         Children (SPPC)</i>	87
Appendix C: Pretreatment and Posttreatment Versions of the <i>Student         Attitudes Questionnaire (SAQ)</i>	91
Appendix D: <i>Content Area Preference Scale (CAPS)</i>	97
Appendix E: Mathematics Curriculum Worksheets	101
Appendix F: Science Curriculum Worksheets	131
Appendix G: Electron Flow Circuit Handout	145

## List of Tables

Table 1.1	Major Features and Achievement Effect Sizes in 11 Studies of Within-Class Grouping	9
Table 2.1	Information on Participating Districts	13
Table 2.2	District Definitions of Giftedness	15
Table 2.3	Definitions of Giftedness in Districts Without Gifted Programs	15
Table 3.1	Number of Groups by Classroom	28
Table 3.2	Arrangement of Data in the Study	28
Table 3.3	Coefficient Matrix for the Individual-Level Analyses	30
Table 3.4	Coefficient Matrix for the Dyadic-Level Analyses	32
Table 3.5	The Percentage of Variance in the Measures Due to Classroom and Group	33
Table 3.6	Reliability of Individual-Level Measures	36
Table 3.7	The Reliability of Perceiver and Target Variance in the <i>Student Attitudes Questionnaire</i>	37
Table 3.8	The Reliability of Perceiver and Target Variance in the <i>Student Attitudes Questionnaire</i> for Change Scores	38
Table 3.9	Pattern of Missing Data	40
Table 4.1	Descriptive Statistics for the Demographic Variables for the Gifted, Non-Gifted, and Overall Samples	41
Table 4.2	Descriptive Statistics of the Academic Measures for the Gifted, Non-Gifted, and Overall Samples	42
Table 4.3	Means and Effect Estimates for Mathematics and Science Ignoring Prior Achievement	43
Table 4.4	Means and Effect Estimates for Mathematics and Science Controlling for Prior Achievement	44
Table 4.5	Mean Number of Worksheets Completed for 42 Classrooms	45
Table 4.6	Descriptive Statistics for Self-Concept Measures	46
Table 4.7	Pretreatment Means by Group and Effect Estimates for the Academic, Social, and Global Subscale Scores from the <i>Self-Perception Profile for Children</i>	47

## List of Tables (continued)

Table 4.8	Means and Effect Estimates for the Changes in Academic, Social, and Global Self-Concept	48
Table 4.9	Descriptive Statistics for the <i>Content Area Preference Scale</i> Measures	49
Table 4.10	Pretreatment Means by Groups and Effect Estimates for the <i>Content Area Preference Scale</i>	49
Table 4.11	Means and Effect Estimates for the Changes in Interest in Subject	50
Table 5.1	Mean Rating of the <i>SAQ</i> Scales and Relationship Standard Deviations	52
Table 5.2	Pretreatment Mean Scores for the <i>Student Attitudes Questionnaire</i>	53
Table 5.3	Effect Estimates for Pretreatment <i>Student Attitudes Questionnaire</i>	53
Table 5.4	Posttreatment Mean Scores for the <i>Student Attitudes Questionnaire</i>	55
Table 5.5	Effect Estimates for the Posttreatment <i>Student Attitudes Questionnaire</i>	55
Table 5.6	Change Score Means	56
Table 5.7	Effect Estimates for the Changes in <i>Student Attitudes Questionnaire</i>	57

# **The Effects of Group Composition on Gifted and Non-Gifted Elementary Students in Cooperative Learning Groups**

David A. Kenny  
Francis X. Archambault, Jr.  
Bryan W. Hallmark

University of Connecticut  
Storrs, Connecticut

## **CHAPTER 1: Introduction and Review of Related Literature**

Cooperative learning has gained widespread acceptance in educational circles over the past decade. Slavin (1991b) reported that whereas few teachers regularly used cooperative methods in the early 1980s, hundred of thousands of teachers were routinely using cooperative learning strategies by the early 1990s. Moreover, they were using these strategies with all types of students in grade levels two through college and in all academic subjects. Numerous studies have shown that cooperative learning positively affects student achievement and self-esteem. Cooperative learning also positively affects the way children relate to one another, particularly children from different ethnic and economic backgrounds. Despite these positive outcomes, a number of observers (e.g., Robinson, 1991; Rogers, 1991) have questioned the appropriateness of cooperative learning for gifted children. Their concern stems in large part from the almost universal use of heterogeneous ability grouping in cooperative learning arrangements, a practice which critics claim helps the non-gifted but harms the gifted (Kulik, 1992). This criticism also stems from the paucity of research evidence supporting the use of cooperative learning with this special population. In a recent review of the literature, Robinson (1991) uncovered 301 ERIC references and 204 PSYCHINFO references on cooperative learning for the period 1967 through 1991, but only three of these references reported original research on the effect of cooperative learning on the gifted. One study included 14 gifted elementary students (Smith, Johnson, & Johnson, 1982), another study included 48 high ability high school seniors and college freshmen attending a summer program (Johnson, Johnson, & Holubec, 1990), and the third study (Kanevsky, 1985) investigated the effects of cooperation versus competition with 40 gifted third and fourth graders. Robinson also reported that very few studies of cooperative learning have been undertaken with high ability students, that the studies which did inquire into the effects of cooperative learning on the gifted often used inappropriate definitions of giftedness, and that these studies used weak treatment comparisons, that is, they compared cooperative learning against traditional classrooms rather than treatments more suited to academically talented students. Thus, Robinson concluded that administrators and teachers using cooperative learning strategies with gifted students are over-generalizing from the available research evidence.

The research described in this report was undertaken to provide researchers, administrators, and teachers with tangible evidence as to the effectiveness of cooperative learning with gifted students. This controlled field experiment was designed to assess the effects of both heterogeneous and homogeneous grouping in cooperative learning settings on the performance of gifted and non-gifted students, including their achievement, self-concept, and attitude toward school subjects, as well as the feelings that they have toward one another. It was also designed to determine whether different types of cooperative learning arrangements implemented in different content areas yield comparable results. The study involved 786 fourth grade students drawn from 42 classrooms located in 8 school

districts. To our knowledge, this is the largest study to date on cooperative learning and the gifted.

## **Cooperative Learning**

According to Slavin (1991c), small-scale laboratory research on cooperation dates back to the 1920s. Deutsch (1949), who completed one of the earliest large studies on the effects of cooperation versus competition, found that individuals working in cooperative groups learned more than individuals working alone. Acknowledging that in both competitive and cooperative situations individuals are motivated to attain their own goals, Deutsch proposed that in cooperative situations the goals of the individuals comprising the group would be consistent with group goals, and, consequently, that individual goal attainment would be tied inextricably to the goal attainment of the group. To Deutsch this meant that if group members did not share the same goals, they would not work together, exchange ideas, and help each other when help was needed. If this occurred, both the group and the individuals within it would not succeed.

Cooperative learning in educational settings involves small groups of students working together to solve problems or complete tasks. Sharan defines cooperative learning as a set of instructional strategies "which employ(s) small teams of pupils to promote peer interaction and cooperation for studying academic subjects" (1980, p. 242). Although numerous cooperative learning models exist, most notably those of Slavin and his colleagues (Slavin, 1986; Slavin, 1990b; Stevens, Madden, Slavin, & Farnish, 1987; Stevens, Slavin, & Farnish, 1991), Johnson, Johnson, Stanne, and Garabaldi (1990), Aronson, Blaney, Stephan, Sikes, and Snap (1978), Sharan and Sharan (1976), and Kagan (1985), and despite the differences which exist among them relative to the extent of cooperation/competition employed and the nature of rewards, all models share certain characteristics. First, students must work together to achieve a common goal or receive a reward. Second, cooperative learning is both a strategy for instruction and a means of grouping students. Cooperative learning groups therefore provide a context which facilitates peer tutoring, promotes task-oriented cooperation and communication, and encourages the exchange of ideas (Sharan, Ackerman, & Hertz-Lazarowitz, 1980). Third, groups must be comprised of at least two individuals, and, for most models, groups of four students are recommended. And fourth, groups should be heterogeneous with respect to ability. More specifically, most proponents of cooperative learning insist that the groups be comprised of one high ability, two medium ability, and one low ability student.

### **Effects on Achievement**

Two meta-analyses of the effect of cooperative learning on achievement have been conducted since 1981, and, as noted above, the evidence suggests that cooperative learning has positive effects on the achievement of students at various age and grade levels. Johnson, Maruyama, Johnson, Nelson, and Skon (1981) reviewed 122 studies investigating the effects of cooperation without competition, cooperation with intergroup competition, interpersonal competition, and individualistic learning and found that both forms of cooperative learning were superior to interpersonal competition or individualistic learning. They reported an effect size (Cohen's *d*) of zero for comparisons involving the two forms of cooperative learning, .78 for comparisons involving cooperative learning and individualistic practices, and also .78 for comparisons involving cooperative learning and competitive practices (Rogers, 1991). They also found that children at lower grades benefited more than older children from cooperative learning arrangements. Although they

found no differences by subject matter, length of treatment did affect outcomes, with shorter treatments producing more favorable results.

Slavin (1990b) conducted a best evidence synthesis involving 60 studies which were selected to ensure that (a) the experimental and control group students were studying the same material, (b) teachers and classes were either randomly assigned to cooperative or control conditions or matched on achievement pre-test or other factors to establish pre-experimental equivalence, (c) the treatment was at least 20 hours long (four weeks) and (d) the achievement tests assessed content taught to both experimental and control group subjects. He reported that 49 of the 68 comparisons performed in these studies (72%) found greater achievement in cooperative than control classes; only 8 (12%) favored control groups. He also found that the effects of cooperative learning varied greatly according to the particular model of cooperative learning used. Across all studies and models the median effect size for achievement was found to be .21. However, the overall effect size for the four Slavin models was .30 with Team-Games-Tournament model producing the largest effect (.38) followed by Student Team Achievement Division model (.27). Few of the other models of cooperative learning produced effect sizes greater than .20, effects generally considered very small in the research literature (Cohen, 1988). It should be noted that the effect sizes in Slavin's review are much smaller but likely more realistic than those of Johnson et al. (1981). Further, none of the studies investigated the effects of cooperative learning on students of differing ability.

Slavin (1991c) concluded from his review that in order for cooperative learning to be effective two elements must be present: group goals and individual accountability. He based this conclusion on the fact that 37 of the 44 studies with these two elements found positive achievement results while only 4 of the 23 studies without these features produced positive achievement outcomes. We turn to Slavin to interpret these findings:

Why are group goals and individual accountability so important? To understand this, consider the alternatives. In some forms of cooperative learning, students work together to complete a single worksheet or to solve one problem together. In such methods, there is little reason for more able students to take time to explain what is going on to their less able group mates or to ask their opinions. When the group task is to *do* something, rather than to *learn* something, the participation of less able students may be seen as interference rather than help. It may be easier in this circumstance for students to give each other answers than to explain concepts or skills to one another.

In contrast, when the group's task is to ensure that every group member *learns* something, it is in the interest of every group member to spend time explaining concepts to his or her group mates. Studies of students' behaviors within cooperative groups have consistently found that the students who gain most from cooperative work are those who give and receive elaborated explanations (Webb, 1982). In contrast, Webb found that giving and receiving answers without explanations were *negatively* related to achievement gain. What group goals and individual accountability do is to motivate students to give explanations and to take one another's learning seriously, instead of simply giving answers. (p. 77)

Slavin also concluded from his review that cooperative learning works equally well for all types of students. Again we turn to Slavin:

While occasional studies find particular advantages for high or low achievers, boys or girls, and so on, the great majority find equal benefits for all types of students. Sometimes teachers or parents worry that cooperative learning will hold back high

achievers. The research provides absolutely no support for this claim; high achievers gain from cooperative learning (relative to high achievers in traditional classes) just as much as do low and average achievers. (p. 77)

### **Effects on Self-Esteem and Interpersonal Relations**

Many advocates also claim that cooperative learning positively affects students' self-esteem and interpersonal perceptions. Improvements in self-esteem have been reported by Madden and Slavin (1983) and by Oickle (1980) for Slavin's Teams-Games-Tournaments and Student Teams Achievement Division models, by Blaney, Stephan, Rosenfield, Aronson, and Sikes (1977), Geffner (1978), and Lazarowitz, Baird, Bowlden, and Hertz-Lazarowitz (1982) for the Jigsaw model, and by Slavin, Leavy, and Madden (1984) for Team Assisted Individualization. Johnson and Johnson (1983) also found positive effects for general and school self-esteem, but they found no differences for peer self-esteem. Gonzales (1979, 1981) and Allen and Van Sickle (1984) likewise found no peer self-differences. De Vries, Lucasse, and Shackman (1980) found positive effects for social but not academic self-esteem; Slavin & Karweit (1981) found positive effects for general and academic but not social self-esteem.

Johnson, Johnson, and Maruyama (1983), in a meta-analysis of the literature on the effects of cooperative learning on the social relationships of ethnically diverse students, handicapped students, and ethnically similar and non-handicapped students, found that cooperation without intergroup competition promoted greater interpersonal attraction among all groups of students than did interpersonal competition, working independently, or cooperation with intergroup competition. For comparisons involving ethnically diverse populations, Johnson et al. reported more positive cross-ethnic attitudes for cooperative versus competitive arrangements (Effect Size = .54) and for cooperative versus individualistic practices (Effect Size = .68). They also reported that cooperation produces more positive attitudes toward handicapped students than either competitive (Effect Size = .86) or individualistic (Effect Size = .96) arrangements and that cooperative learning produces more interpersonal attraction (i.e., liking and respect) among diverse student groups than competitive arrangements.

Summarizing this research, Slavin (1990b) concluded that the evidence concerning cooperative learning and self-esteem is not completely consistent. And, as with achievement, he found weaker effects of cooperative learning on self-esteem than Johnson et al. However, he also points out that positive effects were found in 11 of the 13 studies investigating the relationship between cooperative learning and self-esteem, and he argues that if cooperative learning treatments were used for longer than a few weeks, the typical length of the interventions, that lasting changes in self-esteem might result.

### **Effects on Students' Liking of Class**

Slavin (1990b) speculated that "anyone walking into a class using any of the cooperative learning methods can see that the students enjoy working with each other" (p. 48). He also reports that these students enthusiastically respond "yes" when asked if they like working in cooperative learning groups and if they would like to work in them again. Slavin also acknowledges, however, that the research evidence for this outcome is inconsistent. Some studies have found that students like cooperative learning classes better than control classes (e.g., De Vries, Edwards, & Wells, 1974; Humphreys, Johnson, & Johnson, 1982; Slavin & Karweit, 1981), and others have found no differences in how much students like cooperative or control classes (e.g., De Vries, Mescon, & Shackman, 1975, cited in Slavin, 1990b; Madden & Slavin, 1983; Slavin et al., 1984). Slavin also reports that Blaney et al. (1977) found that Anglos and Blacks liked class more under

cooperative versus control conditions, but that Mexican-American students liked control classes more than those using a cooperative learning approach. Part of the reason for this outcome, according to Slavin (1990b), is that on pretests students tend to report liking class, so “the measurement on the posttest cannot discriminate students who like class more than they did before from those who like it the same as before” (p. 49).

### **Effects on Liking and Being Liked by Classmates**

The relationships among students in cooperative learning arrangements have been assessed using sociometric procedures (e.g., by asking students to name their friends in class) and through questionnaires and attitude scales which ask students to rate others in the class along certain dimensions (e.g., “How well do you like Mike”). Slavin (1978) and Oikle (1980) found positive effects for cooperative learning using sociometric procedures, but neither researcher found differences when questionnaires were used to measure how well students liked others or how well liked students thought they were. De Vries and Edwards (1973) reported increased student scores on a mutual concern questionnaire scale, but not on a cohesiveness scale or on the number of friends named. Slavin and Karweit (1981) found that students involved in cooperative learning treatments named more friends than control students and mentioned fewer classmates when asked to name those with whom they would not want to work. They also found no treatment differences on questionnaire scales measuring liking of classmates or feelings of being liked. Other researchers have also reported interactions between the outcome measures and the types of scales used. The interested reader is referred to Slavin (1990b) for details.

Even critics of cooperative learning have concluded that it positively affects the social relationships of students. Cotton and Cook (1982), in a critical analysis of the Johnson et al. (1983) meta-analysis, determined that cooperative learning was not always the best goal structure for improving achievement and productivity in groups. However, in classroom situations instruction is better structured cooperatively than competitively because, regardless of the impact on achievement, a cooperative structure results in improved interpersonal relations.

### **Cooperative Learning, Ability Grouping, and Gifted Students**

Although the beneficial effects of cooperative learning appear to be well documented, little evidence exists concerning the impact of cooperative learning on the gifted. As noted above, a comprehensive review of the literature by Robinson (1991) uncovered only three empirical studies which specifically examined the effects of cooperative learning on academically talented students. One study included 14 gifted elementary students (Smith et al., 1982); another included 48 high ability high school seniors and college freshmen attending a summer program (Johnson, Johnson, Stanne, & Garabaldi, 1990). In the third study Kanevsky (1985) investigated the effect of cooperative versus competitive arrangements with 40 highly gifted (IQ above 145) third and fourth grade students and found no differences between the two approaches. A number of other published reports have discussed the implications of cooperative learning for gifted students (e.g., Adams & Wallace, 1988; Chance & Chance, 1987; Clifford, 1988; Joyce, 1991; Robinson, 1990; Schatz, 1990; Sicola, 1990; Slavin, 1990a; Slavin, 1991a), but none offer conclusive evidence about the effectiveness of the procedure. Given these findings, Robinson concluded that those who claim that cooperative learning can benefit all students (Augustine, Gruber, & Hanson, 1990; Slavin, 1991c) are over-generalizing from the available research.



Robinson (1991) also criticized studies that investigated the effects of cooperative learning on students classified as high, medium, and low achieving because of the way ability levels were established in those studies. Webb (1982) defined ability as the average of the mathematics and reading stanines on *the Comprehensive Tests of Basic Skills (CTBS)*. She reported the mean stanines of the sample as a whole, but provided no data on the separate groups of students involved in the research. In another study by this same researcher (Webb, 1982) ability was defined as performance on a 40-item mathematics test designed by the teachers in the schools in which the study was conducted. Again, no data on sub-group performance were provided. Lucker, Rosenfield, Sikes, and Aronson (1976) defined high and low ability groups to include those scoring in the top 25% and the bottom 25% on an unidentified measure of reading level. Mervasch (1991) reported two studies in which high and low achieving groups were defined as scoring above and below the median on a teacher made placement test. Other studies have classified students solely on the basis of teacher judgment (Johnson & Johnson, 1981; Johnson, Johnson, Tiffany & Zaidman, 1983) without providing any information on the factors teachers considered or how they made their decisions. Finally, a few studies which discuss subgroups do not define ability levels at all (Johnson, Johnson, & Stanne, 1986; Johnson, Skon, & Johnson, 1980). Robinson (1991) argued that these studies demonstrate one of the difficulties in generalizing cooperative learning research to gifted students and the danger in developing programs and policy statements from this research base:

'High ability' as defined by single achievement measures of basic skill achievement batteries, teacher constructed placement tests, or teacher judgment alone should not be used interchangeably with giftedness. The indicators are too crude to give us a 'picture' of the kinds of students included in the high achieving groups. (p. 12)

Weak comparisons have also been used to assess the impact of cooperative learning with the gifted. One of these involves comparing cooperative learning against the traditional classroom, which is characterized by large group, teacher driven direct instruction and individual seat work. Slavin (1990b), in the best evidence synthesis described above, found that the students in the cooperative learning condition outperformed students in the traditional classroom in 49 of the 68 comparisons performed (72%). However, as noted by Robinson, educators of academically talented students rarely recommend the traditional classroom as the educational treatment of choice for these learners. In fact, Robinson contends that gifted education was born out of resistance to placing academically talented students in lock-step, grade level traditional classrooms, and that "the case for cooperative learning will be compelling to educators interested in talent development only when comparisons are made with classroom practices which are successful with academically talented students" (1991, p. 13). Included in these practices would be acceleration, enrichment activities of various kinds, instruction in higher-level thinking skills, and so forth.

Another shortcoming in the literature on cooperative learning and the gifted is that the majority of the studies conducted to date have relied on tests of basic skills to define student achievement, including tests of spelling, vocabulary, and language mechanics as well as mathematics tests involving computation rather than concepts and applications. This emphasis on basic skills as opposed to higher-level thinking may lead one to question whether cooperative learning is beneficial for average and below average students for all types of learning outcomes. It is a particularly compelling reason, however, for educators of the gifted to approach cooperative learning with caution, because programs for the gifted emphasize higher level rather than basic skills.

The final, and perhaps the most important, quarrel that gifted educators have with those who contend that the literature supports the use of cooperative learning with the gifted

is that almost all of the cooperative learning studies have used heterogeneous ability grouping. Although a number of researchers, most notably Oakes (1985) and Slavin (1987, 1990b), argue that no one benefits from ability grouping and that the children in the lower and middle groups suffer a loss in achievement, academic motivation, and self-esteem, other researchers, including Kulik (1992) and Rogers (1991), contend that some students profit from homogeneous ability grouping. Moreover, they argue that while homogeneous grouping alone results in small gains for gifted students, grouping practices that employ curriculum geared to the ability of the individuals comprising the groups result in substantial gains for high ability students, and for average and low ability students as well. In heterogeneous groups which offer a common curriculum to all group members, gifted children are also likely to master the material more quickly than their less able peers, and without additional challenges, they are likely to become frustrated and bored. Or, if the instruction is group paced, they may be asked to devote large amounts of their time teaching material they already know to other group members and not learn much new material themselves. Proponents of heterogeneous grouping, on the other hand, suggest that the gifted may benefit from being the "teacher" in the group because non-gifted children might develop more positive attitudes toward them and because teaching material to others may help the gifted develop a greater mastery of the material. They also submit that groups comprised exclusively of gifted students may contain too many "chiefs" and that valuable instructional time may be lost to power and leadership struggles within the group.

In order to resolve the debate about the impact of cooperative learning on individuals of differing ability, it is necessary to vary systematically the ability composition of cooperative learning groups. Unfortunately, few studies have done so. In one study on this topic, Beane and Lemke (1971) found that high-ability students benefited more from heterogeneous than homogeneous groups but that the opposite was true for low-ability students. These results may mean that both high- and low-ability students learn more when the other group members are low-ability. Webb (1982, 1984) found no achievement differences due to group composition. She also found that type of group had no effect on group interaction variables, except for the frequency of a student asking a question and receiving no response. Webb reported a significant negative relationship between this interaction variable and achievement. Although these studies begin to shed some light on the effectiveness of different types of ability groups in cooperative learning settings, a large number of questions remain. The cooperative learning study reported here is concerned primarily with the effect on gifted students of homogeneous and heterogeneous cooperative learning groups. It is also concerned with the effects that these grouping arrangements have on non-gifted children. Since this study looks into the achievement, self-concept, interpersonal relations, and interest in schoolwork of students in these two types of grouping arrangements, we turn now to a review of the literature on the effect of grouping on these variables.

### **Ability Grouping and the Achievement of Gifted Students**

The literature on ability grouping contains over 700 references which have been incorporated into at least five meta-analyses (Kulik, 1985; Kulik, 1992; Kulik & Kulik, 1982, 1984, 1990; Vaughan, 1990), two best evidence syntheses (Slavin, 1987; Slavin, 1990b) and one ethnographic/survey research synthesis (Gamoran & Berends, 1987). Reviewers agree that full-time ability grouping has no appreciable effect on the achievement of average and low-ability students (Kulik, 1985, 1992; Kulik & Kulik, 1982, 1984, 1990; Slavin, 1987, 1990b). However, whereas Slavin (1987) contends that this practice also has no effect on gifted students, Kulik and others submit that ability grouping does produce

substantial achievement gains for gifted students enrolled full-time in special programs for the gifted and talented (Kulik, 1985; Kulik, 1992; Kulik & Kulik, 1982, 1984, 1990; Vaughan, 1990). Kulik (1992) also contends that full-time programs which increase the rate at which gifted students learn (i.e., acceleration programs) produce greater achievement gains than enrichment programs. The major adversaries in this debate on ability grouping also agree that grouping by ability without adjusting the curriculum to meet student needs has no effect on the achievement of average and low ability students (Kulik, 1992; Slavin, 1987, 1990b). However, Kulik (1992) contends that it does have a small positive effect on the achievement of high ability students. Kulik (1992) and Slavin (1987) also agree that grouping with curriculum adjustment has a significant effect for students at all levels of ability. Thus, it appears unlikely that grouping alone accounts for the achievement gains. Rather, they are likely the result of what goes on within the group (Kulik, 1992; Rogers, 1991).

No attempt will be made here to describe the methods and findings of each of these reviews or to provide details on the many studies of ability and achievement which they summarize. It will be instructive, however, to look more carefully at Kulik's (1992) review because he describes the effects of various types of grouping strategies, including the practice known as within classroom grouping which was implemented in the present research. Kulik suggests that when used in the literature the term ability grouping may refer to one, several or all of the following practices:

1. **XYZ classes.** Students at a single grade level are divided into groups—often high, middle, and low groups—on the basis of ability level, and the groups are instructed in separate classrooms. Separation may be for the full day or for a single subject only. Reviewers have referred to this approach by such names as ability-grouped class assignment (Slavin, 1987), multitrack grouping (Miles, 1954), and multilevel grouping (Kulik & Kulik, 1992).
2. **Cross-grade grouping.** Children from several grades who are at the same level of achievement in a subject are formed into groups, and the groups are then taught the subject in separate classrooms, without regard to the children's regular grade placement or age. Most cross-grade programs are elementary school programs in reading. Researchers and reviewers sometimes refer to this grouping method as the Joplin plan (Slavin, 1987).
3. **Within-class grouping.** A teacher forms ability groups within a single classroom and provides each group with instruction appropriate to its level of aptitude. This type of grouping has been used frequently for reading and arithmetic instruction in elementary schools. It is sometimes referred to as intraclass grouping (Petty, 1953).
4. **Accelerated classes for the gifted and talented.** Students who are high in aptitude in a subject receive instruction that allows them to proceed more rapidly through their schooling or to finish schooling at an earlier age than other students.
5. **Special enriched classes for the gifted and talented.** Students who are high in academic aptitude receive richer, more varied educational experiences than would be available to them in the regular curriculum for their age level. The instruction is usually, but not always, provided in a separate classroom. The special grouping may be for a full day or a single subject.

Although Kulik reviews the impact of all of these grouping arrangements on the achievement of gifted and non-gifted students, our concern here is with within-classroom grouping. For this type of ability grouping Kulik reviewed 11 studies published between

1927 and 1984. Most of the studies examined single-subject grouping, although one study examined multi-subject grouping. In addition, material was adjusted to group ability in all studies, and grouping was based on a specific aptitude in all but one of the studies. All but one of the studies used standardized tests as criterion measures of students' achievement. The findings are summarized in Table 1.1.

As can be seen in the Table, 9 of the 11 studies found higher overall achievement for students grouped by ability, and 5 of these differences were found to be statistically significant. Two studies found higher achievement for students taught without within class ability grouping. The overall effect size for these studies is 0.25, an effect which is significantly different from zero, but which Cohen (1988) considers small.

Six of the studies reported results separately by ability group. Kulik (1992) reports that the average effect size was 0.30 for higher ability students, 0.18 for average ability students and 0.16 for lower ability students and that the differences are not statistically significant. Based on these findings, Kulik (1992) concluded that within-class grouping has a good record of effectiveness in the literature and that the procedure works for all types of students. Although he suggests that within-class grouping was found to be effective in part because group assignments were typically made within a specific subject area based on a specific skill, the major factor contributing to these results is the adaptation of the curriculum to student level:

Table 1.1

Major Features and Achievement Effect Sizes in 11 Studies of Within-Class Grouping

Study	Starting Grade	Course Content	Duration of Instruction	Overall	Effect Size		
					High	Middle	Low
Campbell, 1965	7	M	1 year	-0.18	0.26	-0.41	-0.36
Cignetti, 1974	7,8	O	9 weeks	0.09	0.27	0.22	-0.41
Dewar, 1963	6	M	23 weeks	0.48	0.47	0.50	0.56
Eddleman, 1971	5	M	9 weeks	-0.09			
Jones, 1948	4	C	1 year	0.21	0.19	0.23	0.40
Putbrese, 1971	4	M	1 year	0.16			
Shields, 1927	7	R	6 weeks	0.82			
Slavin & Karweit, 1984	3-6	M	1 semester	0.43	0.41	0.38	0.50
Smith, 1960	2-5	M	1 semester	0.22	0.18	0.15	0.30
Spence, 1959	4-6	M	30 weeks	0.60			
Wallen & Vowles, 1960	6	M	1 semester	0.06			

Note. C = Combined; M = Mathematics; O = Other; R = Reading  
From Kulik (1992)

Indeed, without such adaptation of material to group level, it would be pointless for a teacher to use within-class grouping. Repeating the same lesson several times for different student groups would be a waste of teacher time and it would thus be a waste of student time. Instead of providing such repetitive lessons, teachers using within-class groups adapt their lessons to their audience. This adaptation may be the key to their success. (Kulik, 1992, p. 33)

## Ability Grouping and the Self-Concept of Gifted Students

### Self-Concept of Gifted Students

Even though gifted students often perform well in school, they do not necessarily have a more positive self-concept than non-gifted children. One possible explanation for this result is that the student might possess excessively high, rigid expectations about his or her performance, or parents' expectations could also be excessively high and unobtainable. In either instance, because the gifted student is unable to match expectations, the student's academic self-worth might be lower than the academic self-worth of a non-gifted student. Hoge and Renzulli (1991), following Freeman (1985), propose that gifted students might also have lowered self-esteem because their increased cognitive ability may make them more sensitive to social cues and more analytic about them. This may, under certain circumstances, incline the child toward a more critical attitude of his or her abilities and performances. Gifted students might also have their self-esteem lowered if they receive instruction in groups comprised only of gifted students since heightened competition may lead them to question their skills and abilities. And finally, it should be noted that gifted students may have higher self-concepts in certain domains than others. A number of researchers (e.g., Marsh, 1990; Hoge & Renzulli, 1991) contend that self-concept is comprised of components or dimensions, one of which, evaluation, is sometimes referred to as self-esteem. However, like Hoge and Renzulli, the usual practice of using the general term self-concept in referring to this evaluation process will be followed here. Hoge and Renzulli contend that the self-concept of the gifted child will be enhanced in those areas in which exceptionality is exhibited, but not necessarily in others.

Given this analysis, it is not surprising that the research evidence regarding gifted students' self-concepts has produced conflicting results. Janos, Fung, and Robinson (1985) investigated the global self-concepts of gifted students and found that, in general, gifted students exhibited higher self-concepts than a normative sample of students. However, gifted students who perceived themselves to be different from other students had lower self-concept scores than gifted students who did not perceive themselves as different. Dean (1977) also reported that the self-concept scores of gifted students did not differ significantly from those of the norm group used to standardize *the Coopersmith Self-esteem Inventory* (Coopersmith, 1967).

Hoge and McSheffrey (1991) investigated the academic and social self-concepts of gifted students enrolled in an enrichment program for gifted children and found that gifted students showed higher academic self-concept scores on *the Self-Perception Profile for Children* (SPPC; Harter, 1985) than a normative sample of students. However, gifted students had lower social self-concept scores. Bartell and Reynolds (1986) investigated whether the self-concept of gifted students was different from the self-concept of a control group of non-gifted students and whether a student's gender moderated their self-concept. They found no differences between gifted and non-gifted students, but they also found that gifted boys scored significantly lower than gifted girls. This gender effect has not been replicated in other studies (Karnes & Wherry, 1981; Milgram & Milgram, 1976).

In a comprehensive review of the literature investigating the self-concept of gifted children, Hoge and Renzulli (1991) summarized 18 published studies comparing the self-concepts of gifted and non-gifted children. All of these studies reported findings on global self-concept; five studies also provided findings on specific domains, such as academic and social self-concept. Nine of the studies reported significantly higher global self-concept scores for their gifted sample, six studies reported no significant differences between gifted and comparison samples, and three studies reported mixed results. None of the studies reported significantly lower self-concept scores for gifted students. Taken together, these results suggest that gifted students appear to have higher global self-concepts than non-gifted students. The five studies which examined specific areas of the self-concept found that gifted students have more positive academic self-concepts than non-gifted students. They also found that there are no overall differences between gifted and non-gifted students in social self-concept.

### **Self-Concept of Gifted Students in Group Settings**

Hoge and Renzulli (1991) reported mixed results from the 10 studies they uncovered which investigated the effect of gifted program placement on students' self-concept. Maddux, Scheiber, and Bass (1982), for example, investigated the self-concepts of gifted children in a segregated enrichment program, in regular classrooms but participating in a pull-out enrichment program, and identified as gifted but not participating in a special program, and found no differences on the Piers-Harris scale for any program type. Kolloff and Feldhusen (1984) compared the Piers-Harris scores for gifted children in a special program with those of gifted students receiving no special treatment and found no differences between the two groups, as did Karnes and Wherry (1981). However, other studies have found positive effects for gifted programs. Schneider, Clegg, Byrne, Ledingham, and Crombie (1989) found that for comparisons involving gifted students in an integrated gifted program (one in which students are pulled out of the regular classroom for part of the day), a self-contained program (students are in a classroom with gifted students throughout the day), and a control condition (students receiving no special instruction), the integrated subjects had greater levels of academic self-concept than students in the other two groups. They also found no differences in global or social self-concept among the three conditions.

Kolloff and colleagues have also found positive self-concept changes as a result of gifted programs. Kolloff and Moore (1989) looked at changes in gifted students' self-concepts over a two-week period in three different summer enrichment programs and found increases in global self-concept for all three programs. Feldhusen, Saylor, Nielsen, and Kolloff (1990) found that students in a twice-a-week pull-out enrichment program showed greater improvement in self-esteem after one year than gifted students who did not participate in such a program. However, few of the subscale scores were found to be significantly different. Finally, some studies have shown a negative effect of gifted programs on students' self-concept. Coleman and Fults (1982) investigated the self-concept of fourth through sixth grade gifted students in a segregated gifted program versus gifted students in a traditional classroom and found that segregated students had significantly lower self-concepts. Coleman and Fults (1985) found that gifted children showed higher self-concept scores prior to a segregated, all gifted program than gifted students currently enrolled in a similar program. Olszewski, Kulieke, and Willis (1987) investigated the change in self-concept of gifted students who participated in one of two summer programs for gifted students. They found small but statistically significant decreases in academic self-concept for both programs. They also found increases in social self-concept in one program, and no changes for the other program. There were no changes in global self-concept for either program.

These mixed results may be due to several factors. First, many of these studies only reported total self-concept scores. However, Byrne and Shavelson (1986) have indicated that comparing mean differences on self-concept is meaningful only if specific subscale scores or domains of self-concept are used in making comparisons. Second, the setting in which subjects complete a self-concept measure could well influence an individual's score. In the study by Kolloff and Feldhusen (1984), for example, students completed the Piers-Harris scale at the end of the school year, when the special gifted program had ended and there was no mention of the reference group for the self-concept ratings. Consequently, one cannot be sure whom students were comparing themselves to when completing the self-concept measures. Third, related to this idea of significant others is the importance of group membership. Individuals generally use similar others when making social comparisons. However, if group membership and performance are important, for example, if students are working in a cooperative learning group, the effects may be quite different.

Harter (1986) has theorized that one's self-concept is influenced in part by the amount of social support and positive feedback one receives from significant others. Because the two major categories of significant others in the life of a child are parents and peers, those students with whom a gifted student comes in contact during instruction and the reaction of those students to the performance of the gifted student might influence the gifted student's self-concept. Marsh (1990) has postulated the Big-Fish-Little-Pond effect with regard to this social comparison issue. For Marsh, a student's feelings of self-worth depends on the average level of performance displayed in the student's school or class. By extension, it might also depend on the average level of performance or ability of a cooperative learning group. Thus, a student in a group with lower ability students might indeed, be a "Big-Fish," be viewed positively by his peers, be reinforced for his performance, and have his or her self-concept improved. Conversely, a student in a group comprised of comparable or higher ability student might receive less reinforcement and suffer a decrement in self-concept.

## CHAPTER 2: Methods

This chapter describes the basic methods and procedures employed in this cooperative learning study. It includes a description of the sampling procedures, the instruments used to collect the achievement, self-concept, attitude and peer relations data, and the procedures used in the delivery of the treatment. Design and analysis issues are described in the next chapter.

### Sample

A total of 42 teachers and 786 fourth grade children representing rural ( $n = 3$ ), suburban ( $n = 3$ ) and urban ( $n = 2$ ) districts designated as Collaborative School Districts by The National Research Center on the Gifted and Talented participated in this research. Each student participated in one of the 262 three-person cooperative learning groups which were constituted for the study.

### Classroom Selection

Fifteen districts were contacted by phone and in person regarding their willingness to participate in this research. Particular emphasis was placed on acquiring districts which were heterogeneous with respect to student ethnicity, and attempts were made to acquire districts in various parts of the country. If a district expressed an interest in participating, a packet of information was sent to the person designated as the district liaison. The packet contained an abstract of the project; a project timeline; an informed consent form for parents; a statement of responsibilities for the district, experimenters, and students; and a letter of agreement, which, if the district agreed to participate, was to be signed by the district Superintendent of Schools and returned to the experimenters. Eight of the districts agreed to participate, five in the northeast, two in the west, and one in the central part of the country (see Table 2.1). Two of the districts are considered urban (although both urban areas had populations of around 40,000 people), three are suburban, and three are rural.

Table 2.1

#### Information on Participating Districts

<u>District</u>	<u>Region of Country</u>	<u>Community Type</u>	<u>Number of Classrooms</u>
1	Western	Rural	1
2	Western	Rural	3
3	Central	Suburban	3
4	Northeast	Suburban	9
5	Northeast	Urban	10
6	Northeast	Urban	10
7	Northeast	Suburban	4
8	Northeast	Rural	2



All fourth grade teachers in the eight districts were asked if they would allow their class to participate in the study, but teachers' participation was completely voluntary. Those teachers agreeing to participate and having a minimum of four academically gifted students in their class were selected for the study.

Districts decided whether or not parental consent was required to allow students to participate. If consent was not required, a letter describing the study was sent to parents. If consent was required, consent forms and a letter describing the study were sent to parents. No student was eliminated due to lack of consent.

### **Group Assignment**

Following their agreement to participate, teachers were asked to complete a class roster which asked them to list the students by first name and last initial only. Teachers were also asked to report on the students' gender, ethnicity, whether he/she took part in a federally subsidized lunch program, and whether he or she was in a special program (for example, English as a Second Language). In addition, teachers were asked to provide information on the students' academic ability, including an ability rating using a five-point Likert scale, whether the students participated in a gifted and talented program, and scores from the most recent standardized achievement test administered by the school district. This information was used to determine if students were academically gifted. For five districts, giftedness was determined by a student's involvement in a gifted and talented program, as described in Table 2.2. For the remaining three districts, giftedness was determined as described in Table 2.3.

Students in classrooms were assigned to three-person groups based on whether they were gifted or non-gifted. There were three group types in each classroom: homogeneous non-gifted, homogeneous gifted, and heterogeneous, which included one gifted and two non-gifted students. The gifted students were randomly assigned to either the homogeneous gifted or heterogeneous groups. Once all of the gifted students were assigned to a group, the non-gifted students were randomly assigned to the homogeneous non-gifted or heterogeneous group. Although four-person groups would have been preferred, they could not be employed given the number of gifted students in class.

### **Measures**

The impact of the cooperative learning treatment was assessed using measures of achievement, self-concept, attitude toward school subjects, and peer relations. Each will be described in turn. Additional details on the reliability of these measures are presented in the next chapter.

#### **Achievement**

Two achievement tests were constructed to assess the effect of the cooperative learning experience on students, one for the mathematics curriculum and one for the science curriculum (see Appendix A). The mathematics measure contained a total of 21 items covering the measurement of area and perimeter (see the curriculum materials section below for more details). Each item correctly answered was worth one point, for a total of 21 possible points. In a pilot of the measurement devices, the mathematics test reliability, as measured by Cronbach's alpha, was found to be .82.

Table 2.2

District Definitions of Giftedness

<u>District</u>	<u>Selection Criteria</u>
1*	<ul style="list-style-type: none"> <li>a) 97th percentile or above on IQ tests (national norms); or</li> <li>b) 97th percentile or above on composite, reading, vocabulary, or math problem solving for the <i>Iowa Tests of Basic Skills</i>; or</li> <li>c) teacher nomination.</li> </ul>
2	<ul style="list-style-type: none"> <li>a) 95th percentile or above for <i>Science Research Associates (SRA)</i> composite score; or</li> <li>b) teacher nomination; or</li> <li>c) individual case studies for students showing exceptional talent.</li> </ul>
3	<ul style="list-style-type: none"> <li>a) 90th percentile or above on composite for <i>Iowa Tests of Basic Skills</i>; or</li> <li>b) teacher nomination.</li> </ul>
4	<ul style="list-style-type: none"> <li>a) 90th percentile or above on the total battery for the <i>Comprehensive Test of Basic Skills (CTBS)</i>; or</li> <li>b) teacher nomination with screening by committee.</li> </ul>
5	<ul style="list-style-type: none"> <li>a) 90th percentile or above on the total battery for the <i>Comprehensive Test of Basic Skills (CTBS)</i>; or</li> <li>b) teacher nominations with screening by committee.</li> </ul>

\* Number assigned to district not same as in Table 2.1.

Table 2.3

Definitions of Giftedness in Districts Without Gifted Programs

<u>District</u>	<u>Selection Criteria</u>
1	<ul style="list-style-type: none"> <li>a) participation in Gifted Program in previous year when program was in operation; or</li> <li>b) 85th percentile or above on <i>Metropolitan Achievement Test</i> composite score; or</li> <li>c) teacher ability rating of 4 (above average) or 5 (superior) for ethnic minorities not selected using (a) and (b).</li> </ul>
2	<ul style="list-style-type: none"> <li>a) participation in Gifted Program in previous year when program was in operation; or</li> <li>b) 85th percentile or above on the <i>Iowa Tests of Basic Skills</i> composite score; or</li> <li>c) teacher ability rating of 4 (above average) or 5 (superior) for ethnic minorities not selected using (a) and (b).</li> </ul>
3	<ul style="list-style-type: none"> <li>a) 90th percentile or above on <i>Stanford Achievement Test</i> composite score; or</li> <li>b) teacher ability rating of 4 (above average) or 5 (superior).</li> </ul>

The science achievement test contained a total of 17 items. The items assessed knowledge of static electricity, current electricity, and electromagnets. Different items on the test had different point values which were assigned to the items on the basis of the amount of information solicited. The six matching items at the beginning of the instrument were worth one point each, items 6, 7, and 9 were worth two points each, item 3 was worth three points, items 2 and 8 were worth four points each, items 1 and 10 were worth five points each, items 4 and 11 were worth six points, and item 5 was worth seven points, for a total of 51 possible points. In the pilot of the instrument, the science test reliability, as measured by Cronbach's alpha, was found to be .75. Both the science and mathematics measures were constructed so that most students would not be able to obtain the maximum possible points. In the pilot of the materials, no student obtained a perfect score on either measure.

### Self-Concept

A modified version of the *Harter Self-Perception Profile for Children (SPPC)*; Harter, 1985) was used to measure students' self-concept (see Appendix B). This instrument, which is designed to assess elementary-aged children's self-concepts, has a total of six self-concept subscales, only three of which were used in the present research.

The three subscales used were global self-concept, academic self-concept, and social self-concept. The global self-concept scale provides a measure of how children feel about their lives in general; for example, do they feel important. The academic self-concept scale measures whether children feel that they do well in school, for example, do they feel that they are doing well in school or are other people doing better. The social self-concept scale measures whether children feel they are popular. These three subscales were selected because they were the most pertinent subscales for purposes of this study. In addition, using only three of the six sub-scales reduced testing time, an important consideration in this study.

Each of the subscales contained a total of six, forced-choice items for a total of 18 items for the modified scale. In a pilot study, the reliabilities for the global, academic, and social self-concept sub-scales were found to be .80, .84, and .76, respectively. The same version of the scale was administered prior to treatment and after treatment.

### Peer Relations

Peer relations was assessed through the *Student Attitudes Questionnaire (SAQ)* which was designed expressly for the present study. This instrument asked each person in each three-person group to rate the other two group members with regard to eight characteristics on the pretest and ten characteristics on the posttest. Pretest characteristics included the following:

- (1) How well they *know* the student;
- (2) How *friendly* the student is;
- (3) How good a *teammate* the student is;
- (4) How *smart* the student is;
- (5) How much they *like* the student
- (6) How much they *play* with the student after school;
- (7) How *shy* the student is;
- (8) What kind of a *leader* the student is.

For the posttest, we no longer asked how well they knew the other students in the group, but we added three other characteristics:

- (1) How much *help* the student provided;
- (2) How much *they helped* the other students;
- (3) How much they would like to be in *another group* with the student.

All ratings were assigned using a four-point scale which varied by item, as shown in Appendix C.

### The Content Area Preference Scale

The *Content Area Preference Scale (CAPS)* (Kulikowich, 1990) was developed to measure student preference toward subjects such as mathematics and science. The *CAPS* consists of 3-point Likert items where students circle either a happy face (I agree with the statement), an uncertain face (I neither agree nor disagree with the statement), or a sad face (I disagree with the statement). An initial pool of 40 items was developed for the original scale, which included items assessing preference toward reading, mathematics, science, and social studies. All items were inspected for the suitability of vocabulary through two basic means. First, textbooks at the elementary school level were inspected for commonly used words and phrases. Second, teachers who had experience working with elementary school children (grades 2-6) were asked to inspect the items and suggest changes they saw necessary. Two pilot studies were performed to eliminate poor items and to reduce the item pool from 40 to 20. The 20 items were then examined for reliability using an extensive set of procedures (Kulikowich, Reis, Owen, & Smist, in preparation). These procedures resulted in four science items and four mathematics items. The reliability coefficient for each scale, as measured by Cronbach's alpha, exceeded .80. A copy of these scales is included in Appendix D.

### Curriculum Materials

Two sets of curriculum materials were developed for this study: a mathematics curriculum and a science curriculum. The mathematics curriculum was concerned with measuring the perimeter and calculating the area of objects. The science curriculum was concerned with electricity. Copies of the worksheet used in implementing the two curricula are provided in Appendices E and F, respectively.

The mathematics curriculum was a basic-skills, worksheet-based instructional unit which included twenty-three worksheets organized in increasing levels of difficulty. For example, the first worksheet had groups measure the lengths of lines, the thirteenth worksheet asked students to estimate the area of a square, and the twenty-third worksheet asked students to estimate the area of circular objects. Although the worksheets progressively became more difficult, to maintain the basic-skills nature of the task, some material from earlier worksheets was repeated on later worksheets. The mathematics curriculum is thus similar to Student Teams Achievement Division (STAD) developed by Slavin (1990b).

The mathematics curriculum was designed to minimize instructor contact with students and maximize group interaction. This was accomplished in several ways: (1) by limiting instructor introduction to the topic of perimeter and area to 10 minutes on the first day of instruction; (2) by ensuring that all subsequent information necessary to complete the worksheets was given to groups in the form of instructional sheets; and (3) by allowing all groups to work at their own pace. Once a group completed a worksheet, the members were able to correct the worksheet, and continue to the next worksheet.

The science curriculum was a more creative, idea-generating task. It contained three separate worksheets which covered four areas of electricity: static electricity, current electricity, conductors and insulators, and electromagnets. On each day of instruction, groups received a brief five-minute introduction to one of the four topic areas and a worksheet which contained all the information necessary to complete experiments and to answer questions regarding the results of these experiments.

## Procedures

The study was implemented in 10 class sessions of approximately one-hour duration each over a three-week time span by seven experimenters with extensive teaching experience. Each experimenter received two days of intensive training. The first day focused on general procedures, data collection, and miscellaneous responsibilities; on the second day the experimenters practiced the procedures with a classroom of students. Experimenters assumed the role of teacher while in the classroom. They answered all student questions relative to the curriculum and dealt with any discipline or other problems that arose. The regular teacher remained in the classroom, and assisted the experimenter only when asked. The specific procedures which were implemented each day of the 10-day regimen are described below.

**Day 1:** Experimenters introduced themselves to the students in the classroom and gave the following explanation for being there:

Researchers at the University of Connecticut are interested in how well fourth graders work in groups. What everyone will be doing over the next several weeks is working in a group. Everyone will be in the same group for the entire time. During this time each group will work on a series of math and science problems. Following your work on each set of materials there will be a quiz. There will be a total of two quizzes. Before we get started, there are a few questionnaires that I would like everyone to fill out.

The experimenter distributed the *SPPC* scales to all students and read the following:

All the surveys and quizzes that you fill out during this project are confidential, that means secret. Only you and the researchers at the University of Connecticut will ever know what you write. No one in your class, school, or at home will ever find out what you write down. This means that none of your fellow students, your teacher, or your parents will ever see what you put on a survey.

The experimenter read each *SPPC* question to the class as they completed the scales. This procedure was implemented to ensure that students would be able to understand all of the questions, as recommended by Harter (1985).

When students had completed the *SPPC* and forms were collected, the experimenter explained what groups are and how successful groups work:

A group is several people working together. For instance, groups work together to complete a goal, such as learning about math and science. One thing which happens in all groups is that groups interact. That is, people in groups talk to each other. So not only will you get a chance to talk in class, but you should talk. But you should only talk to those people in your group. Successful groups

communicate or talk frequently to their group members. This is so that everyone learns and knows what the group is doing.

Before you get into your groups there are some rules which everyone must follow. (The experimenter hung a poster of the following rules in front of the classroom.) Here are the rules that you must follow in your group.

1. Each group is responsible for working as a cooperative team.
2. Each team member is to give suggestions and help in completing the team assignment.
3. Each team member will seek help from members.
4. Each team member will help each other learn.
5. Each team will complete team sheets together.
6. Each team member will take the quiz. You will take the quiz by yourself, but you can help each other by helping others on your team learn.
7. If a team member has a question, he/she should ask the group before asking teachers. This is to make sure that everyone on the team has tried to solve a problem.

Now everyone will get into a group. We have made up your groups in advance. The groups were created randomly. Does anyone know what randomly means? Randomly is like the lotto. It means that we threw everyone's name into a hat, pulled out three names, and those three people were in the first group. We then pulled three more names out of the hat, and those three people were in the next group. We did this until there were no names left in the hat.

Homogeneous and heterogeneous groups were formed prior to this initial meeting using procedures described above. Each student was given an index card with his/her name and a color-coded group designation. Students were told to keep these cards for the length of the experiment. Once all of the cards were distributed, students were assigned to desks which had been arranged so that they were facing each other in groups of three. The class was told that they would sit in the same place every time they formed groups.

The experimenter then distributed the SAQ's to each student and reminded them of the confidential nature of the surveys. The experimenter also emphasized that it was important for the students to be quiet and not to look at other's surveys. Completed SAQ's were collected when all students had finished the task.

A 17 piece jigsaw puzzle was then distributed to each group. The puzzles spelled out the statement, "None of us is as smart as all of us." Groups were told to complete the puzzle together, and were given 10 minutes to finish the task. When ten minutes had passed, groups were told to stop working, whether or not the puzzle was complete. Students were asked about the meaning of the statement on the puzzle. The experimenter explained that the statement meant that when people work together they can complete more than when they work independently. In addition, the experimenter told the groups that it was important for members to work together and to talk to each other.

The experimenter closed out the day by asking the students to return to their regular seats and telling them that they would be doing math or science at their next meeting.

**Day 2:** The experimenter began by reminding students of the cooperative learning rules which were displayed at the front of the classroom and reminded students that it was important to follow these rules. The experimenter then provided a brief introduction to area

and perimeter and explained how to complete and score the worksheets. The introduction of the mathematics and science curricula was counterbalanced across classrooms to eliminate a possible order effect. When mathematics was introduced first a discussion of the procedures was presented (see below).

For the next several days your group will complete several worksheets exploring the area and perimeter of objects. The perimeter of an object is the measurement of distance around the object. (The experimenter would then draw a rectangle on the board and trace its perimeter.) The perimeter of this desk top is the measurement of the edges of the desk. The area is the measurement of how much space is within a perimeter. (The experimenter would shade in the area of the rectangle on the board.) So the area of this rectangle is how much is inside the rectangle. You will be measuring objects in centimeter units. I will give each of you a centimeter ruler so you can measure things. A centimeter is about the size of the nail on your pinky finger. All of the worksheets your group receives will explain how to measure the perimeter and area of objects, but if your group cannot figure something out, you can ask me. One of the special things about working in a group is that everyone shares doing everything. Because of this, each person in a group gets to come up to me and get a worksheet, take the worksheet back to the group, and come up and get the answer key. Once you correct the sheet, the next person brings me the corrected worksheet and answer key. We have put a number on the bottom of the name card that I gave you yesterday. The person with a number one is the first person who will come up to me. The person with a number two is the second person to come up, and the person with a three is the third person to come up. After the third person is done, the first person comes up, then the second and third persons. This continues for all of the math days.

This rotation of students was implemented to attempt to reduce the chances that one person would take charge of the group as a result of obtaining materials from the experimenter.

The experimenter then had the students form groups. Person one in each group was told to come to the experimenter to get the first worksheet. This student took the worksheet back to the group, which then worked to complete the worksheet. When the worksheet was complete, person one showed the completed worksheet to the experimenter (thus ensuring that the group did complete the worksheet), and the experimenter gave person one the answer key for that worksheet. Person two then obtained the second worksheet, and, following completion of it by the group, retrieved the answer key from the experimenter. The experimenter checked that the group understood what they answered on the worksheet. Person two then took the next worksheet back to the group, and the group worked on it. This process continued throughout Day 2.

At the end of Day 2, the experimenter asked all groups to stop working, and told them that they would continue working on whatever they did not finish the next time they met.

**Day 3:** The experimenter again posted the cooperative learning rules, and reiterated the importance of following them and cooperating with group members. The students were then directed to reform their groups. The experimenter distributed the work that each group had not completed on Day 2. The groups continued to work as described above.

**Day 4:** The procedures from Days 2 and 3 were followed, as described above.

**Day 5:** The experimenter posted the cooperative learning rules, and reminded students of the importance of following these rules and cooperating with group members. The students were then directed to reform their groups. The experimenter then distributed the work that each group had not completed on Day 4 and directed students to continue to work as they had on Day 4.

After thirty minutes had passed the experimenter collected any uncompleted worksheets and/or answer keys from the groups and asked students to return to their regular seats. The experimenter then distributed the mathematics achievement test and read the following directions:

The test you are taking is very important. It is important that you do the best you can. If you don't know an answer, that's okay, but try to answer everything you can.

In almost every class a student asked if the test was part of their grade, to which the experimenter gave the following response:

How you do on the test is not part of your grade in the class. However, what you do today will affect all fourth graders throughout the United States. So, for example, if you have a younger brother or sister, what you do today will affect your brother or sister when they are in the fourth grade. So you can see it is important for you to do the best you can.

After this explanation was given, students in the class became very quiet, and eager to receive the test. During the test, students appeared to work diligently. Thus, it appeared to the experimenters that students took the test seriously.

A total of 25 minutes was allotted for this test. At the end of the 25 minutes tests were collected whether or not students had answered all questions. In most cases, students completed the test within the 25-minute period.

**Day 6:** The experimenter provided the following feedback regarding the test to all classrooms:

The people from the University graded your tests. They told me to tell you that you all did an excellent job. Your class did better than most classrooms that are in the study; all of you are very smart fourth graders. All of you should give yourselves a hand (students would clap their hands).

If a student asked about their personal performance on the test, they were told the following:

Everything that you do in this study is confidential. That is, no one knows what anyone does in the study. You see, the people at the University put all of a classroom's surveys and forms in a pile, they put a number on everyone's forms, and they cut everyone's names off the form. So all anyone ever knows is how well your class did. No one can ever see what you put on a test or survey.

This explanation appeared to remove concerns students had regarding test performance. Immediately following the test feedback, the experimenter introduced the science curriculum (or the mathematics curriculum if science was introduced first):



We are going to learn about electricity for the next few days. You will get the chance to work on several areas of electricity, including static electricity and electromagnets. I think all of you will love exploring the world of electricity.

The experimenter then asked "Where do you see electricity?" All reasonable answers were accepted. The introduction continued:

There are two kinds of electricity: Static and Current. (The experimenter would draw a stick person wearing a large sweater with a balloon next to the sweater. On the sweater, the experimenter would draw a "+" and a "-".) The sweater is filled with electrical charges which are both negative (the experimenter would circle some of the "-" s) and positive (the experimenter would circle some of the "+" s). The positive charges, the pluses, are called protons. The negative charges, the minuses, are called electrons. Pretend that I am wearing a long-sleeved coat. What would the coat have on it? (Any answer, such as "Charges," "Protons," "Electrons," "Pluses," "Minuses," was accepted.)

The electrons like to move, and they move to where there are more protons than electrons. (Using the drawing on the board, the experimenter would show the "-" going to where there are more pluses.) Where in your house do you hear or see static? (Any reasonable answer was accepted).

Following this discussion the experimenter again posted the cooperative learning rules and reminded the class to follow them. The students then returned to their groups.

The experimenter distributed to each group a kit of materials needed to complete the static electricity worksheet. This kit contained: 20 pieces of puffed rice, a small balloon, a 15 cm. X 15 cm. piece of wool fabric, and a small plastic bag. Each group was also given a static electricity worksheet, which they had approximately 40 minutes to complete. The experimenter walked among the groups checking students' answers while they worked. This was done so that groups had immediate feedback on their progress, as well as to ensure that the groups were generating acceptable solutions to the problems. It should be noted that since there were many possible correct answers for a problem, some better than others, experimenters checked only to see that answers were reasonable and thus that students were on target.

After about a 40-minute work period, the experimenter collected the materials kit. The groups then were given approximately 5 minutes to discuss their answers to the problem. After 5 minutes, the experimenter collected the worksheets. The experimenter concluded Day 6 by saying, "Tomorrow we will learn about another type of electricity, called current electricity."

**Day 7:** The experimenter reminded the class about the cooperative learning rules posted in the front of the class. In addition, the experimenter stated, "You want to remember the rules of cooperative learning. It is not always easy to cooperate, but the more you share and help those in your group the more you will learn and the more fun you will have." The experimenter then introduced the current electricity topic:

We are going to learn about current electricity for the next two days. You will not have time to finish your worksheet today, but that is okay. In the picture is a circuit. You can see that the minuses, the electrons, are moving or flowing to the pluses, the protons.

When electrons move towards the protons, we call this an Electron Flow. If the electrons are able to reach the protons, that is, nothing is in their way, then we call this a complete circuit. When the electrons flow through a light bulb on their way to the protons, the bulb will light up. Our goal today is to have you discover where you have to touch the bulb and battery with a wire or wires to complete the circuit and make the bulb light.

The experimenter then directed students to form their groups and distributed to each group a kit of materials which contained the following: two D cell batteries, two 15 cm. pieces of copper wire, one 7 cm. piece of copper wire, and one flashlight bulb. Each group also was given one current electricity worksheet which they had approximately 40 minutes to complete. The experimenter again checked answers as groups completed their worksheets.

At the end of the 40-minute work period, the experimenter collected the materials kit and the worksheet. The experimenter then told the groups that the current electricity worksheet takes two days to complete, and that all the groups would have the opportunity to finish their worksheet the next time they met. The experimenter concluded Day 7 by saying, "Tomorrow you will get the chance to finish your worksheets and learn about insulators and conductors."

**Day 8:** The experimenter posted the cooperative learning rules in front of the room and reminded students about the need to cooperate. The concepts of conductors and insulators were introduced to the class:

Yesterday you learned how to complete a circuit. Today you will break a circuit, and learn what materials will let electrical current flow through to complete the circuit again. The experimenter drew the following on the board:

a complete circuit: -----  
 an incomplete circuit: ----- ----  
 a complete circuit with conductor: ----\_-----

A *conductor* allows electrons to flow through the circuit enabling the bulb to light. An *insulator* does not allow the flow of electrons to continue, so the bulb cannot light. So, when two wires are not connected like in this drawing on the board, only material that is a conductor will allow the electrons to flow through and make the bulb light.

The experimenter next had students reform their groups. One kit of materials which contained items necessary to complete the second part of the current electricity worksheet was distributed to each group. This kit contained: two D cell batteries, two 15 cm. pieces of copper wire, one 7 cm. piece of copper wire, one flashlight bulb, one 4 cm. square of aluminum foil, felt, paper, one piece of chalk, one paper clip, and one pencil. Each group's worksheet from Day 7 was returned, and the groups had approximately 35 minutes to complete the worksheet. At the end of the 35-minute work period, the experimenter collected the materials kit. Groups then were given another 5 minutes to discuss their worksheet, following which worksheets were collected.

The experimenter asked students to surround him or her so he or she could show them how to connect wires to a battery holder and a bulb holder, which they would have to do on Day 9. The experimenter concluded Day 8 by saying, "Tomorrow we will get the chance to use a bulb and battery holder and will discover things about electromagnets."

**Day 9:** The experimenter began this session by providing students with the following introduction to electromagnets:

Electricity can be used to magnetize metal. Electromagnets are made from a coil of wire wrapped around a rod or nail. When electricity flows through the wire coil it produces more electrons in the nail. These electrons cause the nail to become a temporary magnet. It will remain magnetic as long as the electrical current continues to flow.

Do you recall when we put more electrons on the balloon by rubbing it with the wool? We found out that the more electrons were on a balloon, the more rice was attracted to it. Like the balloon, the more electrons the nail has the more it can pick up objects which are made of metal. However, unlike the balloon, an electromagnet needs power, like that from a battery, to attract metal.

To increase the number of electrons in a balloon we rubbed it more times. To make an electromagnet stronger you must also increase the number of electrons. There are several ways to do this, and you will experiment with these in your group.

The groups reformed. One kit of materials which contained items necessary to complete the electromagnet worksheet (two D cell batteries in battery holders, two 15 cm. pieces of copper wire, one 7 cm. piece of copper wire, one flashlight bulb in a bulb holder, one 10 cm. nail wrapped with 20 coils of copper wire, one 10 cm. nail wrapped with 40 coils of copper wire, and 50 paper clips) was given to each group along with one electromagnet worksheet, which groups had approximately 25 minutes to complete. Experimenters again checked the answers while the groups worked on this task.

The experimenter collected the materials kit at the end of the 25-minute work period. The groups were given approximately 5 minutes to discuss the worksheets. After 5 minutes, the experimenter collected the worksheets.

Next the students, while still in their groups, completed the *SAQ* and the *SPPC*. The experimenter ended Day 9 by stating, "Tomorrow you will get a chance to show the people at the University how much you learned by completing a quiz on the science material that your groups have explored for the last three days or so."

**Day 10:** The science achievement test was administered using the same instructions given prior to the mathematics achievement test. Similar to the mathematics test, students were given a total of 25 minutes to complete the science test. All students were able to complete the test in the allotted time.

Following the test, students were thanked for helping the experimenter and the University. In addition, they were encouraged to express their feelings about the cooperative learning experience in an open classroom discussion.

Approximately 2-3 days later the following statement was read to the class by the classroom teacher:

Researchers at the University of Connecticut, particularly (*experimenter's name*) who was working in your room, want to thank (*teacher's name*) fourth grade class for doing so well in both their science and math lessons. The good work that you did will help other fourth graders throughout the country.

## **General Protocol**

Several policies followed during the field portion of the study should be described. First, when an experimenter provided help to students three rules were followed: (1) the help was always at the group level, that is, the whole group received the same help; (2) experimenters attempted to provide strategies, not answers to questions; and (3) when a student requested help from a teacher or an experimenter, the student was asked if he or she had asked the group first, that is, all requests for help had to be made by the group, not the individual.

In addition, the student's attention was always directed towards their own group and away from other groups. Experimenters actively worked to decrease competition among the groups. For example, if some students or groups were comparing performance with members of other groups, the experimenter would tell students that this was not a race and that they were not to compare themselves to students in other groups, or to the groups themselves. The experimenter also told the students that as they made new discoveries they should keep it in their own group.

In an effort to maximize within-group cooperation, the experimenter told the students approximately every other day to make sure that they taught the others in their group how to do any procedure that they knew or learned. Also, the experimenter told groups that to do some of the activities they would need "two sets of hands" (i.e., need help). In addition, if group members appeared to be frustrated with their teammates, the experimenter would tell them "cooperation is not always easy; so, it is important that you talk with each other, and try to always be nice to your teammates."

When a particular student's behavior required discipline, the experimenter would work with the teacher to develop a response which was congruent with that of the teacher's. Such action was required in very few instances.

### **Pilot of Procedures, Curriculum, and Instruments**

Following numerous revisions by the research team, a pilot study was conducted with 18 fourth grade students in a rural Connecticut district. Thus, a total of six, three-person groups were involved in the trial, which was conducted by one of the experimenters and witnessed by the researchers. Based on this trial, several minor modifications were made to the procedures and curriculum. First, the puzzle given to groups on Day 1 was simplified because the original version required too much time to complete. Second, the procedures for distributing and collecting the science materials were modified to allow students more time to complete tasks. And, third, several minor changes, such as displaying the poster daily and eliminating experimenter explanation of the day's task on each day of the science lessons, were made. Overall, the original procedures were successful, and students reported that they enjoyed participating in the pilot. These modifications in procedures are incorporated in the above description.

Both the mathematics and science curriculum also were modified as a result of the pilot. Originally, there were 18 worksheets for the mathematics curriculum. However, because the homogeneous gifted group completed worksheet 18 on the last day of group activities, five more worksheets were developed in an attempt to eliminate any ceiling effects in the curriculum. The science curriculum originally contained a section covering series and parallel circuits. Because of time constraints, and based on the advice of the curriculum writers, this section was dropped from the study. Further, the material covered during current electricity was expanded. This expansion of the current electricity section

was done in order to increase the depth at which electron flow was introduced to the subjects.

## CHAPTER 3: Design and Analysis Issues

This chapter considers the basic design and analysis plan for the study. There is also a discussion of reliability, control variables, and missing data. Occasionally the material in this chapter is somewhat technical, and it may be of interest to only a limited audience.

### The Basic Analysis Model

The basic design treats classroom as the fundamental unit. Within each classroom, three different types of three-person groups were created: homogeneous gifted, homogeneous non-gifted, and heterogeneous (1 gifted and 2 non-gifted). To distinguish the groups, the homogeneous gifted group will be labeled HG, the homogeneous non-gifted group HN, and the heterogeneous or mixed group M. In most classrooms, multiple groups of each type were created.

As noted in the previous chapter, a total of 42 classrooms from 8 different school districts was studied. Table 3.1 presents the number of groups by type for each of these classrooms. As can be seen from the table, there are 50 homogenous gifted groups in the study, 79 heterogeneous groups, and 133 homogeneous non-gifted groups, for a total of 262 groups. Because the groups are three-person, there are a total of 786 children in the study.

There are two levels of measures in the study. First, there are individual-level measures. They include the achievement scores on mathematics and science, the self-concept measures, and the interest in curriculum measures. Second, there are dyadic measures, which are the measures of peer perceptions. These measures are dyadic in the sense that a score refers to two persons: one child's perception of another. We turn now to a discussion of the analysis model for the individual-level measures and then the analysis model for the dyadic measures.

### Individual-Level Measures

A single analysis plan was developed for the individual-level measures of achievement, self-concept, and interest in the curriculum. The description of that strategy will be phrased in terms of the achievement tests, but the approach applies to the other measures as well.

The basic data analysis strategy is to first estimate effects for each classroom. Then, using classroom as the unit, the mean of the effect estimates is tested to determine whether it is significantly different from zero by a one sample t-test. The test statistic is the average estimate across classrooms multiplied by the square root of the number of classrooms from which the estimate is derived divided by the standard deviation of the estimate.

Effect estimates were also calculated for the individual level measures. For each classroom we can compute the means for four different groups of children: homogeneous gifted (MHG), heterogeneous or mixed gifted (MMG), heterogeneous non-gifted (MMN), and homogeneous non-gifted (MHN). These four means can be arranged as if they formed a two-by-two design, as in Table 3.2.

Table 3.1

Number of Groups by Classroom

Cl.	HG	M	HN	Cl.	HG	M	HN
1	1	1	5	22	1	2	4
2	1	1	4	23	1	1	4
3	2	3	2	24	1	3	3
4	1	1	4	25	1	1	5
5	2	3	1	26	1	1	1
6	1	1	4	27	2	1	1
7	1	1	5	28	2	1	3
8	1	3	3	29	1	3	2
9	1	3	2	30	1	1	4
10	3	3	2	31	1	3	3
11	1	2	2	32	1	1	6
12	1	2	3	33	1	3	3
13	1	3	1	34	1	2	3
14	1	1	3	35	1	2	3
15	1	1	1	36	1	2	3
16	1	1	5	37	1	3	3
17	3	3	2	38	1	2	3
18	1	2	4	39	1	1	4
19	1	2	2	40	1	3	2
20	1	2	2	41	1	1	7
21	1	1	5	42	1	2	4
Totals					50	79	133

Table 3.2

Arrangement of Data in the Study

Partner		
<u>Actor</u>	<u>Gifted</u>	<u>Non-gifted</u>
Gifted	Homogeneous (1)	Heterogeneous (2)
Non-gifted	Heterogeneous (3)	Homogeneous (4)

For illustrative purposes, consider first the case in which there are only two children in each group. Looking at the box in the Table 3.2, cell (1) contains the homogeneous gifted group. Each child (i.e., *actor*) in this type of group is gifted and the other child in the group (i.e., *partner*) is also gifted. In cell (2), we find the gifted child in a heterogeneous group. That child is gifted and his or her partner is not gifted. In cell (3) is the non-gifted heterogeneous group. That child is not gifted and his or her partner is gifted. Finally, in cell (4) is the homogeneous non-gifted group. The actor is not gifted and neither is his or her partner.

Looking across the two rows of Table 3.2, we can determine whether gifted children learn more than non-gifted children averaging across whether they were in homogeneous or heterogeneous groups. This effect will be referred to as the *actor effect*. It measures the effect of a variable on the child's achievement.

Looking down the columns, we see the effect of being in a group with a gifted partner. That is, all children in the left column (cells 1 and 3) had a gifted partner, and all of those who are in the right column (cell 2 and 4) have a non-gifted partner. So this main effect refers to whether one's achievement improves when one has a gifted partner, regardless of whether one is gifted or not. This type of effect will be called a *partner effect*.

The interaction in a 2 x 2 design refers to the average of the two cells in the descending diagonal versus the average of the two cells in the ascending diagonal cells. The descending diagonal (cells 1 and 4) are the two homogeneous groups, and the ascending diagonal (cells 2 and 3) are the heterogeneous groups. So the *actor by partner interaction* measures the relative superiority of heterogeneous versus homogeneous groups. We will then refer to this factor as *grouping*. It can be interpreted as the interaction of actor and partner. That is, does a gifted partner improve performance more when a child is not gifted?

The basic design and analysis plan for two person groups was developed by Kramer and Jacklin (1979). In the current study, there is a complication for the non-gifted students in the heterogeneous groups. Because we have three person groups, non-gifted students have two partners: one partner is gifted and other is non-gifted. Thus, unlike dyads, we cannot simply average means to compute *actor*, *partner*, and *grouping* effects. What we must do is to create a model. The model for three person groups is identical to the model for Table 3.2, but it allows for multiple partners. There are four terms in the model:

- (1) constant, or *c*: the average level of response;
- (2) actor, or *a*: the advantage that gifted children have;
- (3) partner, or *p*: the advantage of having one more gifted partner; and
- (4) grouping, or *g*: the advantage of being in a homogeneous group.

If any of these effects are not advantages but disadvantages, the term would be negative. For instance, if children learned more in groups with more non-gifted children, the partner effect would be negative.

The set of equations by which the effects of the various groups are determined is as follows:

$$\begin{aligned} \text{MHG} &= c + a + 2p + g \\ \text{MMG} &= c + a - 2p - g \\ \text{MMN} &= c - a - g \\ \text{MHN} &= c - a - 2p + g \end{aligned}$$



Notice that there is no partner effect of the heterogeneous non-gifted students because those children have one gifted and one non-gifted partner.

The model parameters employ what is called *effect coding* (Cohen & Cohen, 1983). With effect coding, the effect must be doubled to obtain the difference between the two types of students. The *actor effect* measures the effect of being gifted relative to the average child in the study. The difference between a gifted and a non-gifted child would be twice the actor effect. The *partner effect* measures the effect of having a gifted child in the group. To assess the effect of changing the group from two non-gifted to two gifted partners the partner effect must be multiplied by four. It is first doubled because of the coding system and doubled again because there are two partners in the group. Finally, the grouping effect would need to be doubled to measure the relative advantage or disadvantage of homogeneous versus heterogeneous grouping.

With these four mean scores, the constant, actor, partner, and grouping effect can be estimated. The estimates were obtained by multiplying each mean score by the weighting coefficients provided in Table 3.3. As an illustration, consider the actor effect. If for a given classroom the means are MHG = 25, MMG = 24, MMN = 19, and MHN = 18, then the actor effect (the advantage that gifted children have over non-gifted children) would be:

$$25/6 + 24/3 - 19/3 - 18/6 = 2.83$$

So, in this hypothetical classroom, gifted children outperform the average child by 2.83 points and the advantage of a gifted child over a non-gifted child would be 2 times 2.83, or 5.66. The statistical significance of each effect is determined by testing if the mean of the effect averaged across classrooms was statistically different from zero.

The self-concept and CAPS pretest and change scores were also analyzed using this model. For change, each person's pretreatment score was subtracted from his or her posttreatment score. A positive score indicated an increase in self-concept or interest in the subject. The constant in the model was meaningful and assessed whether self-esteem or interest in the topic increased for the entire sample.

Table 3.3

Coefficient Matrix for the Individual-Level Analyses

	MHG	MMG	MMN	MHN
Constant	1/3	1/6	1/3	1/6
Actor	1/6	1/3	-1/3	-1/6
Partner	1/6	-1/6	1/6	-1/6
Grouping	1/6	-1/6	-1/3	1/3

## Dyadic-Level Measures

The analysis model for the interpersonal perception variables is similar to the model just described. Effect estimates are computed for each classroom, averaged, and then tested for statistical significance. However, there is one important difference in the interpersonal perception data: they are dyadic. Thus, a score refers not to a child, but rather to a child and one other person in the group. The model described above is for scores that refer to individuals.

In this study, four basic dyads can be created: (1) a gifted child rating a gifted child (GG); (2) a gifted child rating a non-gifted child (GN); (3) a non-gifted child rating a gifted child (NG); and (4) a non-gifted child rating a non-gifted child (NN). There are two types of NN dyads in the study: those in heterogeneous groups (NNM) and those in homogeneous non-gifted groups (NNH). There are then five types of scores: GG, GN, NG, NNH, and NNM. These five means can be computed for each classroom.

In addition to the constant, actor, partner, and grouping effects, an extra effect was estimated because of the dyadic nature of the data. This extra effect measures how non-gifted students rated non-gifted students in heterogeneous groups relative to how non-gifted students rated non-gifted students in homogeneous groups. This effect will be referred to as the *relativity effect*.

The terms of the model are similar to the previous model, but there are important differences in meaning, as follows:

- (1) constant, or *c*: the average level of perception;
- (2) perceiver, or *a*: how much more positively gifted children see others;
- (3) target, or *p*: how much more positively gifted children are seen by other children;
- (4) similarity, or *g*: how much more positive the perceptions are when the target is similar to the perceiver;
- (5) and relativity or *h*: how much more positive perceptions of non-gifted children are of each other when they are in a homogeneous group (relativity means a non-gifted child's perception of a non-gifted when there are 3 non-gifted children—a homogeneous group—versus 2 non-gifted children—a mixed group).

Note that the relativity effect can be measured for the perception of non-gifted children of each other, but it cannot be measured for the perception of gifted children of each other.

The model equations (subject subscripts omitted) are:

$$\begin{aligned} MGG &= c + a + p + g \\ MGN &= c + a - p - g \\ MNG &= c - a + p - g \\ MNNH &= c - a - p + g + h \\ MNNM &= c - a - p + g - h \end{aligned}$$

As with the individual level measures, effect coding is used. If one wished to have an effect size measure, one would need to multiply the effect size (except constant) by two.

The coefficient matrix for dyadic variables is contained in Table 3.4. By way of example, to estimate the *target effect* in perceptions of smartness, the five means would be multiplied by the constants in the third row of Table 3.3 and summed.

Change scores were computed for the following measures: leadership, friendly, shy, smart, like, teammate, and playmate. For the change score, the constant term represents an increase or a decrease in peer perception over the course of the study.

### Variance Partitioning of the Individual-Level Measures

The data in this study can be aggregated at three other levels: classroom, group, and person. The classroom level consists of variation due to a multitude of variables, including district, teacher, experimenter, instruction, and prior instruction on the topic. (Classrooms also may have different norms or attitudes.) And, because the intervention began in January in some schools and ended in May in others, the age of the children is reflected in classroom effects. Presumably, classroom might affect achievement, but it should not have much effect on self-concept.

A very important question is the role of the group in determining the child's learning and perceptions. Both critics and advocates of cooperative learning have emphasized the important role that the group plays in determining achievement and perceptions of self and others. The expectation then is for the group to be an important component in determining variance.

Certainly the dominant source of variance in all of the measures is person. However, it should be remembered that all of the error variance in the measure is attributed to the individual.

The technical name for the design of this study is a *hierarchically nested design*. That is, people are nested in three-person groups, and groups are nested in classrooms. The levels are classroom, groups, and person. One can conduct an analysis of variance which is akin to a one-way analysis of variance. But in this analysis, group and classroom are independent variables. In the analysis, person, classroom, and group were treated as random variables, and one can estimate the amount of variance at each level.

Table 3.4

#### Coefficient Matrix for the Dyadic-Level Analyses

	MGG	MGN	MNG	MNNH	MNNM
Constant	1/4	1/4	1/4	1/8	1/8
Perceiver	1/4	1/4	-1/4	-1/8	-1/8
Target	1/4	-1/4	1/4	-1/8	-1/8
Similarity	1/4	-1/4	-1/4	1/8	1/8
Relativity	0	0	0	1	-1

In doing this analysis, it is important to remove confounds due to ability and experimental condition. For instance, some groups contain more gifted children than others, and so we would expect that those groups would outperform groups with no gifted children. Thus, some of the variance between groups is due to the way in which groups were formed. Consequently, variance due to experimental condition was removed in all of the analyses. Additionally, for the analysis of the achievement and academic self-concept data, variance due to prior achievement was also removed. The computer software required that such control variables be measured at the nominal level. So we took the prior achievement variable and created multiple categories.

In Table 3.5 are the variances for classroom and group. The residual or error variance includes variance due to person. Looking first at achievement, it is clear that classroom is an important source of variance, since it explains over 10 percent of the variance for both mathematics and science. The large amounts of variance due to classroom have theoretical implications for the decision concerning unit of analysis.

Interestingly, for science there is no evidence of group level variance. Although every effort was made to make science a group activity, surprisingly, learning did not operate at the group level. That is, if one person in the group learned a great deal, others did not also necessarily learn. However, for mathematics there was evidence of a group effect, meaning that some groups learned more than others. Perhaps because the mathematics curriculum was self-paced, learning depended on the group to which a person was assigned.

Table 3.5

The Percentage of Variance in the Measures Due to Classroom and Group<sup>a</sup>

<u>Variable</u>	<u>Classroom</u>	<u>Group</u>
<b>Achievement</b>		
Mathematics	15.52	10.23
Science	11.54	.04
<b>Self-concept Pretreatment</b>		
Academic	.05	.06
Social	.16	4.81
Global	4.44	.71
<b>Self-concept Change</b>		
Academic	.02	.00
Social	2.10	.93
Global	.46	10.46

<sup>a</sup> Negative variances set to zero.

If we use 5% as a cutoff for meaningful variance, there is no evidence for either classroom or group variance in the pretreatment measures of self-concept and subject interest. For change in these measures, only global self-concept shows evidence of a group effect. Perhaps changes in global self-concept were related to the mathematics achievement test.

### Choice of Unit of Analysis

Person, group, or classroom could be chosen as the unit of analysis, and good reasons could be given to support each choice. Because groups were formed within classroom and because instruction was delivered at the classroom level, it could be argued that classroom is the natural choice. However, because the person is placed within a group and because the intervention was designed to enhance group effects, it could also be argued that group should be the unit of analysis. Finally, in most analyses of data, the individual is the unit of analysis, and so an argument for the individual as the unit of analysis can also be made.

The individual was not selected as the unit of analysis for several reasons. First, individual could not be the unit for the dyadic measures. Because a dyadic measure refers to a pair of persons rather than a single person, it is not even clear to which of the two persons the score should be assigned. Second, there was evidence for the achievement measures of classroom variance (see Table 3.5), and for mathematics there was evidence for group-level effects. If classroom and group effects were ignored in the analysis, the significance tests would be biased because of violation of the non-independence assumption (Kenny & Judd, 1986). Variance due to classroom could be removed by the use of dummy variables, but the generalizations of the study would be limited to only the specific classrooms studied. Moreover, it did not seem feasible to add over 200 dummy variables to control for the effects of group.

The choice of group as unit of analysis was intriguing, but there were some serious difficulties. First, we could not conduct the analysis using group means because for the heterogeneous groups we were interested in within-group performance. Thus, we needed a between-group and within-group comparison. Besides, a group-level analysis suffers from the same problems as the individual level analysis in that it ignores classroom level variance.

Classroom was attractive for a number of reasons. First, the basic design was set up in that way. Second, by using classroom as the unit, many important sources of variance could be controlled. Third, it allowed for a conclusion across classrooms. If either group or individual were used as the unit of analysis, the results would refer only to the particular classrooms sampled. Fourth, it allowed for a parallel analysis for the dyadic-level and individual-level variables.

However, there is one major drawback in using classroom as unit: power. If classroom is the unit, the sample size is only 42, whereas if group or individual were the unit, the sample size would be in the hundreds. But the loss in power is not nearly as dramatic as is conventionally thought. Certainly, power is lost through reduced sample size, but much of that loss of power is recouped through the data aggregation. Some of the significant effects found in this study were also found to have effect sizes less than those that Cohen (1988) calls small. So, if we had enough power to detect effect sizes that are smaller than small, there is no real harm in using classroom as the unit. This decision is reinforced by the fact that when we repeated analyses at the individual level, the typical

result was that conclusions were virtually identical to those for the classroom-level analyses.

Using classroom as the unit, the analysis is a form of hierarchical linear modeling (Bryk & Radenbush, 1992). That is, estimates are computed at one level (the person within classroom) and then these estimates serve as the dependent variable. An issue arises, however, concerning whether or not these estimates should be weighted. For instance, if one class has only 3 groups and another class has 8 groups, should the class with more groups count more?

We decided not to weight for three reasons. First, it is not clear what the weights should be. Because the observations within groups may not be independent, the weighting is not straightforward. Second, as we saw in Table 3.1, the number of groups do not differ very much and so weighting would likely have little effect on the conclusions. Third, the analysis is already complicated enough, and we did not wish to add further to its complexity.

## **Reliability of the Measures**

### **Individual-Level Measures**

Internal consistency (Cronbach's alpha) estimates of reliability for the individual-level measures are presented in Table 3.6. The pretest measures show reasonable levels of reliability. The change scores show much lower reliability, which is to be expected (Cohen & Cohen, 1983). As Overall and Woodward (1975) demonstrated, it is possible for a change score to have zero reliability and yet there could be a high power in the test of treatment effects.

### **Dyadic-Level Measures**

The dyadic measures can also be assessed for reliability. We used the non-gifted homogeneous groups because they should be the most representative groups. Table 3.7 presents the reliabilities for the perceiver and target effects. Consider the variable "leadership," which is derived from each child's rating of the other two members of the group on this variable. The perceiver effect measures the extent to which some people see others as leaders whereas others do not. The target effect measures the extent to which some people are seen as leaders. Although the reliabilities are not as high as they are for individual-level measures, they are about as high as they are for peer ratings by college students (Kenny, Albright, Malloy, & Kashy, 1994). Also, it should be realized that these estimates are conservative because they are within-group estimates which ignore between-group differences.

Some variables exhibit relatively low measures of reliability, particularly the Not Shy variable. Recall that this was the one measure for which higher values were associated with less of the trait.

Table 3.6

Reliability of Individual-Level Measures

---

<u>Variable</u>	<u>Reliability</u>
Achievement	
Mathematics	.82
Science	.75
Self-concept Pretreatment	
Academic	.80
Social	.78
Global	.78
Self-concept Change	
Academic	.44
Social	.32
Global	.49
CAPS Pretreatment	
Mathematics	.78
Science	.79
CAPS Change	
Mathematics	.56
Science	.59

---

Table 3.7

The Reliability of Perceiver and Target Variance in the *Student Attitudes Questionnaire*

<u>Variable</u>	<u>Perceiver</u>	<u>Target</u>
Pretreatment		
Know	.73	.63
Friendly	.38	.45
Teammate	.60	.65
Smart	.43	.45
Like	.74	.72
Leader	.50	.42
Play With	.71	.64
Not Shy	.32	.39
Posttreatment		
Friendly	.53	.57
Teammate	.43	.56
Smart	.58	.62
Like	.68	.65
Leader	.52	.55
Play With	.72	.67
Shy	.18	.29
Another Group	.39	.46
You Help	.57	.13
They Help	.52	.48

Note. Results based on 114 homogeneous non-gifted groups.

Table 3.8 presents the reliability of the change score measures. As would be expected, they are considerably lower than the pretreatment and posttreatment reliabilities.



Table 3.8

The Reliability of Perceiver and Target Variance in the *Student Attitudes Questionnaire* for Change Scores

<u>Variable</u>	<u>Perceiver</u>	<u>Target</u>
Pretreatment		
Friendly	.50	.36
Teammate	.43	.58
Smart	.50	.37
Like	.42	.34
Leader	.19	.12
Play With	.53	.38
Not Shy	.33	.36

Note. Results based on 114 homogeneous non-gifted groups.

### Control Variables

In an analysis model it is important to control or make adjustments for variables which are hypothesized to influence the outcomes but are not controlled through sampling. This section describes how such controls were implemented in this study.

#### Pretest Measures

For a number of measures, children were pretested before the intervention began. Because gifted children were expected to score higher than non-gifted children on these measures, groups had to be equated for differences on the pretest.

There are two strategies to equate groups: change score analysis and regression-based adjustment. In a change score analysis the dependent variable is calculated by subtracting each person's pretest from his/her posttest. In regression-based adjustment, the pretest is entered as a predictor in the equation. Judd and Kenny (1981) argue that change score analysis is preferred if pre-existing groups are used which are members of two populations. We felt that this closely resembled our situation, and so we used change score analysis. One assumption that Judd and Kenny discuss for change score analysis is that the causes of the measures equally affect those measures at both times. Given the short interval between pretest and posttest, this assumption is relatively plausible.

#### Prior Achievement

Pretests were not administered for the mathematics and science achievement tests. It was our expectation that children would not have received prior instruction concerning these topics, and so a pretest would be inappropriate. Also, a pretest in both mathematics and science would have consumed valuable time. We had a little more than 7 hours of instruction (3 of the 10 hour being devoted to testing), and we decided not to sacrifice any more of that time to pretesting.

Standardized test scores (e.g., *Iowa Tests of Basic Skills*) were thus used as a covariate to equate children on prior achievement. To achieve this equation we performed the same analysis on the covariate as we did the outcome variable, but we deleted cases for which the outcome scores were missing. We then had an actor, partner, grouping, and constant score on the covariate for each classroom, and when we analyzed the actor effect of the outcome, we entered the classroom covariate actor effect as the covariate in the analysis. We also used prior achievement as a covariate in the analysis of academic self-concept because the two were highly correlated.

### **Order of the Curriculum**

In about half of the 42 classrooms the mathematics curriculum was introduced before the science curriculum. This between-classroom variable generally had no effect on the measures. Consequently, it will not be reported in the following chapters and will be omitted from the analysis. Because we only had 42 classrooms, we could not afford to unnecessarily control for a classroom-level variable.

### **Classroom**

Within-classroom analyses remove classroom variance. However, for any analysis not done at the classroom level, we always removed the variance due to classroom. We did so by creating 41 dummy variables for classroom.

### **Group**

Certainly group could be a powerful variable. But by using classroom as unit, we control for the effect of group.

### **Other Variables**

If we were to have undertaken individual-level analyses, we would have examined the role of individual-level variables, such as gender and ethnicity. Because most classrooms had about a 50/50 split in terms of gender, and because we did a classroom level analysis, it was not necessary to control for gender. Also, because there were proportionately about the same number of non-Whites in the gifted and non-gifted groups, it was also not necessary to control for ethnicity.

### **Missing Data**

There are three major issues concerning missing data. First, an accounting is needed of the number of missing data points and the reasons for them. Second, it is important to discuss how missing data were handled in scale construction. Third, missing values needed to be estimated for the prior achievement measure.

### **Sources of Missing Data**

Table 3.9 presents information on missing data. Included in the table are the number of individuals and classrooms with complete data. For a group to have complete data, all three individuals would need to be measured. For a classroom to have complete data, at least one member from all four experimental groups would have to be measured.

Table 3.9

Pattern of Missing Data

Variable	Individual	Classroom
Achievement		
Mathematics	770	42
Science	764	41
Self-concept	719	40
<i>CAPS</i>	759	42
<i>SAQ</i>	693	35
Entire Sample	786	42

Achievement data are missing due to absences on testing days. Note that there were only 16 missing cases for mathematics and 22 missing cases for science. Only one child out of 786 was missing both test scores.

Absences also contributed to missing data for both the *SPCC* and the *CAPS*. For these measures, it was possible to be missing both pretest and posttest scores which explains the greater number of missing cases.

For the *SAQ*, we needed data from all three members of the group. Also to simplify the analysis, we used a listwise deletion procedure. So if a group was missing from the pretest, it was considered as missing for the posttest. A total of 693 individuals and 231 groups drawn from 35 classrooms were included in the *SAQ* analyses.

### Estimation of Prior Achievement

For 89% of the sample, the school district provided a percentile score on a standardized achievement test. A percentile score by definition is not normal. In order to normalize the distribution of the prior achievement score, we used the probit transformation (Kenny, 1987). The probit is the Z-score or standard normal deviate, that corresponds to the probability. So a percentile of 50 implies a probit of zero; a negative probit implies a score below the 50th percentile and a positive probit score implies a score above the 50th percentile. The scores are in standard deviation units, and so a percentile of 95 implies a probit of 1.64. Because a probit of zero is undefined, we treated percentiles of zeros as 0.5.

For the mathematics and science achievement tests, we had no pretest. We needed, therefore, to control for prior ability. We developed a strategy to estimate the standardized achievement score of those who did not have scores. We adopted a regression approach to this problem. We first regressed students' standardized achievement test score (probit transformed) on the variables of teacher ratings, gifted versus non-gifted, participation in a special program, and classroom. We created 41 dummy variables for classroom to control for its effect. The regression equation was an accurate predictor of the standardized test scores, the  $R^2$  being .92 ( $p < .001$ ). Using this regression equation, we could create a predicted prior achievement test score for those children who were missing that score.

## CHAPTER 4: Results for the Individual-Level Measures

This chapter presents the results from the individual-level measures used in the study. These measures are achievement (mathematics and science), self-concept (ability, social, and global), and interest in schoolwork (mathematics and science). Because the analysis model is different for the interpersonal relations measures, results for those measures are presented in the next chapter.

### Descriptive Data for Sample

Table 4.1 presents descriptive information for the sample. A total of 786 children participated in the study of which 29% were classified as gifted. Of course, gifted students were oversampled in this study, and so it is not typical to find that 29% of the students in a classroom are gifted. Because of the over-sampling of gifted students, it is not really appropriate to look at the overall means of the sample to determine the representativeness of our results. The means and the standard deviations of the non-gifted children are likely more representative of the schools sampled. So in computing effect size measures we used the standard deviation of the non-gifted students.

More females than males participated in this study, but the split is nearly 50/50. The sample is predominantly White, but there are about 13% non-Whites in both the gifted and non-gifted groups. About 50% of the non-White group were African Americans. Asian students appear to be somewhat over-represented among the gifted group.

Table 4.1

#### Descriptive Statistics for the Demographic Variables for the Gifted, Non-Gifted, and Overall Samples

Variable	Gifted		Non-gifted		Overall	
	%	n	%	n	%	n
Gender						
Female	51.5	118	53.1	296	52.7	414
Male	48.5	111	46.9	261	47.3	372
Race/Ethnicity						
White	87.3	200	87.6	488	87.5	688
Hispanic	2.2	5	3.2	18	2.9	23
African American	4.4	10	6.8	38	6.1	48
American Indian	.4	1	.4	2	.4	3
Asian American	4.8	11	1.6	9	2.5	20
Other	.9	2	.4	2	.5	4

## Review of Analysis Model

In Chapter 3, the basic analysis model was presented. There are four terms in the model:

- (1) Constant: the average score;
- (2) Actor: the advantage or disadvantage of gifted children;
- (3) Partner: the effect of having one more gifted child in the group; and
- (4) Grouping: the advantage or disadvantage of homogeneous grouping.

All effects are scaled in the direction of the advantage that gifted children have. So if an effect is negative, then it is a disadvantage to be gifted or to have a gifted partner. Similarly, grouping is scaled as the advantage of homogeneous over heterogeneous grouping.

We will often use an effect size measure to describe how large an effect is. The measure, a form of Cohen's *d*, is defined as the effect divided by the standard deviation of the non-gifted group. In describing change, the constant will be divided by the pretest standard deviation. Given the way both actor and the grouping effects are scaled (see Chapter 3), they will be doubled before dividing through by the standard deviation. The partner effect will be quadrupled to measure the difference between having two non-gifted partners versus two gifted partners. Following Cohen (1988), .2 is considered a small effect size, .5 a moderate effect size, and .8 a large effect size.

## Achievement Results

Table 4.2 presents descriptive information for the mathematics, science, and prior achievement tests. As can be seen, the science test has a mean and a standard deviation about twice the size of the mathematics test. This fact should be taken into account in interpreting the results for these tests. We will often need to assess how different means are or how large an effect is. To do so, we will divide the effect estimate by the standard deviation of the non-gifted children. If the dependent measure is a change score, then the standard deviation of the pretest is used.

Table 4.2

### Descriptive Statistics of the Academic Measures for the Gifted, Non-Gifted, and Overall Samples

Variable	Gifted			Non-gifted			Overall		
	Mean	sd	n	Mean	sd	n	Mean	sd	n
Mathematics	14.52	3.61	226	10.30	3.89	544	11.54	4.26	770
Science	28.78	7.03	225	19.74	7.55	539	22.40	8.47	764
Prior Achievement	91.6	6.6	229	47.1	22.5	557	63.7	29.1	786

We can also see that the average prior achievement test score for the gifted children measured as a percentile was approximately 92 and for the non-gifted the average score was approximately 47. Thus, in terms of standardized test scores, the gifted children are well above average and the non-gifted children are about average.

### Basic Analysis of Raw Scores

Table 4.3 presents the means for the four groups of children. Looking at the means for mathematics and science, we see that the gifted children score much higher than the non-gifted children. Turning to the effect estimates, the actor effect for both mathematics and science are positive. So what was seen in the means is also true in the effect estimates. The actor effect size (ES) for mathematics is 1.01 and for science it is 1.25. Because .8 is considered to be a large effect size, effect sizes of one or more are larger than large. Quite clearly there are large differences in performance between gifted and non-gifted children.

With regard to the partner effect, the effect of having one more gifted child in one's group, there is a positive effect for mathematics (ES = .20) and a negative effect for science (ES = -.08). With regard to the effect of grouping, gifted children perform better in a homogeneous group rather than a heterogeneous group (ES = .17) when they are studying mathematics. However, non-gifted children do better in a heterogeneous group than a homogeneous group (ES = .11). For science this pattern reverses. Gifted children perform slightly better in heterogeneous groups than homogeneous groups (ES = .06). Non-gifted children, on the other hand, perform better in homogeneous groups than heterogeneous groups (ES = .06). However, it should be kept in mind that none of these effects are statistically significant.

Table 4.3

#### Means and Effect Estimates for Mathematics and Science Ignoring Prior Achievement

Variable	Means			
	HG <sup>a</sup>	MG	MN	HN
Mathematics	14.92	14.26	10.68	10.27
Science	28.86	29.28	19.44	19.90

Variable	Effect Estimates			
	Constant	Actor	Partner	Grouping
Mathematics	12.62	1.97*	.18	-.03
Science	24.29	4.77*	-.15	.08

\*  $p < .05$

<sup>a</sup> where  
 HG = Homogeneous Gifted Group  
 MG = Mixed Gifted (i.e., one gifted with two non-gifted children)  
 MN = Mixed Non-gifted (i.e., two non-gifted with one gifted child)  
 HN = Homogeneous Non-gifted

If we attempt to piece together all of these results, there is an indication for a positive partner effect for mathematics and a negative partner effect for science. However, neither effect is statistically significant. Thus, we conclude that children performed the same whether their partners were gifted or not. Given the effect sizes reported above, it also appears that for achievement there is no difference between homogeneous and heterogeneous groups.

### Basic Analysis With an Adjustment for Prior Achievement

There was no a pretest for the achievement measures. So we do not know whether gifted children learned more as a result of cooperative learning, or they already knew more than non-gifted children before the intervention began. One strategy to control for prior knowledge is to use prior achievement as a covariate in the analysis. However, controlling for prior achievement is not equivalent to a pretest. Because standardized tests are part of the definition of "giftedness" in some districts and because standardized test scores correlate strongly with giftedness in this sample ( $r = .78$ ), when we control for prior achievement we remove much of what is meant by giftedness. In fact, one could even conceptualize our prior achievement variable as a continuous measure of giftedness. Using this conceptualization, we would expect no actor effect of giftedness to remain after we control for prior achievement. Nonetheless, we controlled for prior achievement to remove preexisting differences.

There is a substantial correlation between the mathematics and science test scores found following the cooperative learning experiences and prior achievement, as measured by standardized tests, namely,  $r = .54$  and  $r = .60$ , respectively. Table 4.4 summarizes the achievement results when prior achievement is accounted for. As can be seen in this table, the actor effect reported in Table 4.3 vanishes when prior achievement is taken into account. Further, as was the case for the previous analysis, there are also no partner or grouping effects. It thus appears that being in either a homogeneous or heterogeneous group has no appreciable effect on the mathematics and science achievement of either gifted or non-gifted students.

Table 4.4

#### Means and Effect Estimates for Mathematics and Science Controlling for Prior Achievement

Variable	Means			
	HG	MG	MN	HN
Mathematics	12.63	12.24	12.20	11.78
Science	20.83	21.80	20.54	20.77

Variable	Effect Estimates			
	Constant	Actor	Partner	Grouping
Mathematics	12.12	.16	.14	-.07
Science	20.88	.43	-.20	-.08

## Additional Analyses

### Number of Worksheets Completed

For the mathematics curriculum, students completed worksheets. In Table 4.5, we have the number of worksheets completed for each of three types of groups. Each group could complete from 1 to 23 worksheets. Using Classroom as the unit of analysis, the multivariate  $F(2, 39)$  is 9.27 ( $p < .001$ ). Follow up analysis indicated that students in homogeneous gifted groups completed the most worksheets while students in homogeneous non-gifted groups completed the least.

We can ask whether the number of worksheets depends solely on the number of gifted children in the group. If the process were additive, the mixed group would be nearer the homogeneous non-gifted group than the homogeneous gifted group, which is what appears to be happening. The  $F$  can be partitioned to a univariate  $F$  for additivity and a second univariate  $F$  for nonadditivity. The  $F$  for additivity is highly significant ( $p < .001$ ) whereas the  $F$  for nonadditivity is not significant. Thus, the differences between worksheets completed is entirely explainable in terms of the number of gifted children in the group.

### Easy Versus Difficult Items

One possibility is that gifted children overlearned the easy items in the heterogeneous groups, whereas the gifted children learned more of the difficult material in the homogeneous groups. To test this hypothesis, we separated the mathematics test into easy and difficult items. However, we found no evidence to support this hypothesis.

### Different Criterion for Giftedness

It is also possible that districts may have used too lenient a definition of giftedness. So we used different criteria to define giftedness. Using either the 90 and the 95 percentile on prior achievement to define giftedness, we found little or no change in our results.

Table 4.5

#### Mean Number of Worksheets<sup>a</sup> Completed for 42 Classrooms

Group	Mean
Homogeneous Gifted	20.65
Mixed	18.89
Homogeneous Non-gifted	18.23

<sup>a</sup> Maximum score of 23.



## Self-Concept Results

Table 4.6 presents descriptive statistics for the self-concept data. Each of the three self-concept scores are derived by summing across six items with four choices per item. Consequently, scale scores can range from 6 to 24. As can be seen in the table, self-concept scores were available for 719 of the 786 students. The table also reveals that gifted children scored higher than their non-gifted peers for all three of the self-concept measures on both the pretest and the posttest.

Table 4.7 presents the means and the effect estimates for the pretreatment measures. The analysis is based on 40 classrooms. Looking first at the actor effect, we see that gifted children have a higher academic self-concept than non-gifted children. Moreover, the effect size ( $ES = .80$ ) is quite large. However, when prior achievement is controlled this effect is no longer significant ( $ES = -.27$ ). Likewise, the difference between gifted and non-gifted children's social self-concept is also not significant ( $ES = .19$ ). For global self-concept, however, gifted children do have a more positive self concept ( $ES = .32$ ), and this effect is statistically significant.

With regard to the partner and grouping effects, there is no evidence of any differences for these two effects prior to the cooperative learning intervention (see Table 4.7). Because the children had not yet interacted in cooperative learning groups, there would be no expectation of either type of effect.

Table 4.6  
Descriptive Statistics for Self-Concept Measures

Variable	Gifted		Non-gifted		Overall	
	Mean	sd	Mean	sd	Mean	sd
Pretest						
Academic	19.88	3.08	16.37	4.24	17.44	4.24
Social	18.32	3.99	17.10	4.70	17.47	4.53
Global	20.26	3.54	18.86	4.29	19.30	4.13
Posttest						
Academic	20.08	3.28	17.39	4.21	18.21	4.14
Social	18.08	4.24	17.31	4.73	17.55	4.60
Global	20.56	3.75	19.27	4.54	19.66	4.35
	n = 219		n = 500		n = 719	

Table 4.7

Pretreatment Means by Group and Effect Estimates for the Academic, Social, and Global Subscale Scores from the *Self-Perception Profile for Children*

Variable	Means			
	HG <sup>a</sup>	MG	MN	HN
Academic				
Unadjusted	20.14	19.52	16.40	16.25
Adjusted <sup>b</sup>	17.59	17.13	18.60	18.47
Social	18.41	18.10	17.37	17.24
Global	20.40	20.48	19.13	18.99
	Effect Estimates			
Variable	Constant	Actor	Partner	Grouping
Academic				
Unadjusted	18.14	1.69*	.13	.05
Adjusted	18.00	-.64	.10	.03
Social	17.82	.44	.07	.01
Global	19.76	.68*	.01	-.06

\*  $p < .05$

<sup>a</sup> where      HG = Homogeneous Gifted Group  
                   MG = Mixed Gifted (i.e., one gifted with two non-gifted children)  
                   MN = Mixed Non-gifted (i.e., two non-gifted with one gifted child)  
                   HN = Homogeneous Non-gifted

<sup>b</sup> Means adjusted by prior achievement covariate

Table 4.8 presents the means and effects estimates for the self-concept change scores. As can be seen in the table, the academic, social, and global self-concept of all four groups of student improved from pretest to posttest, except for the social self-concept of both homogeneously grouped gifted students and heterogeneously grouped non-gifted students. With regard to effects, the significant constant effects for academic self-concept mean that the academic self-concepts of all students taken together improved from pretest to posttest. However, and being mindful of the fact that the effects are weak and not statistically significant, the negative effects for actor mean that non-gifted children's academic self-concepts increased more than those of gifted children. Actor effects were not found for the other measures.

Table 4.8

Means and Effect Estimates for the Changes in Academic, Social, and Global Self-Concept

Variable	HG	Mean Change		
		MG	MN	HN
Academic				
Unadjusted	.22	.45	1.23	.99
Adjusted <sup>a</sup>	.81	1.07	1.35	1.09
Social	-.39	.06	-.24	.33
Global	.08	.38	.05	.55

## Effect Estimates for the Academic, Social, and Global Self-concept Subscales

Variable	Constant	Actor	Partner	Grouping
Academic				
Unadjusted	.72*	-.39	.00	-.12
Adjusted <sup>a</sup>	1.08*	-.14	.00	-.13
Social	-.14	-.02	-.17*	.12
Global	.19	.03	-.14	.11

\*  $p < .05$ 

With regard to partner effect, the significant difference for social self-concept is quite small ( $ES = -.14$ ), but nonetheless interesting. This result means that when there are more gifted children in a group, children's social self-concept declined whether they were gifted or non-gifted. This same result was found for global self-concept, but the effect was not statistically significant.

Finally, none of the grouping effects was found to be statistically significant. This means that children's academic, social, and global self-concept were not affected by being in either heterogeneous or homogeneous groups.

**Interest in Subject**

Table 4.9 presents descriptive statistics for the *CAPS* which measured students interest in mathematics and science. Each measure is the sum of four 3-point items. The range of possible response is from 4 to 12. *CAPS* data were available for 759 of the 786 students. Higher scores indicate greater interest in the topic.

Table 4.9

Descriptive Statistics for the Content Area Preference Scale Measures

Variable	Gifted		Non-gifted		Overall	
	Mean	sd	Mean	sd	Mean	sd
Pretest						
Math	11.45	1.73	9.90	2.18	10.06	2.07
Science	9.68	2.20	9.66	2.22	9.66	2.21
Posttest						
Math	10.48	1.87	9.95	2.28	10.11	2.18
Science	9.99	2.11	9.89	2.31	9.90	2.25
	n = 225		n = 534		n = 759	

In Table 4.10 are the means and the effect estimates for the CAPS pretest measures based on 42 classrooms. There is only one statistically significant difference. Gifted children are more interested in mathematics than non-gifted children (ES = .24). This difference also appears for science (ES = .03), but it is not statistically significant.

Table 4.10

Pretreatment Means by Groups and Effect Estimates for the Content Area Preference Scale

Variable	Means			
	HG <sup>a</sup>	MG	MN	HN
Math	10.60	10.20	9.75	9.92
Science	9.74	9.76	9.68	9.47
Variable	Effect Estimates			
	Constant	Actor	Partner	Grouping
Math	10.14	.26*	-.04	.12
Science	9.68	.07	.03	-.07

\*  $p < .05$

<sup>a</sup> where:  
 HG = Homogeneous Gifted Group  
 MG = Mixed Gifted (i.e., one gifted with two non-gifted children)  
 MN = Mixed Non-gifted (i.e., two non-gifted with one gifted child)  
 HN = Homogeneous Non-gifted

Table 4.11 presents means and the effect estimates for pretest to posttest changes in the CAPS. The analysis is based on 42 classrooms. There is only one statistically significant difference in the two measures. All children were more interested in science after the study than they were before ( $ES = .12$ ). All of the other effects are quite small and do not approach statistical significance. The most plausible explanation of this difference is that children found the science curriculum very interesting.

Table 4.11

Means and Effect Estimates for the Changes in Interest in Subject

Variable	Mean Change			
	HG <sup>a</sup>	MG	MN	HN
Mathematics	.02	.04	.17	.02
Science	.24	.36	.23	.26

## Effect Estimates (reversed)

Variable	Constant	Actor	Partner	Grouping
Mathematics	.07	-.04	.02	-.06
Science	.26*	.04	-.02	-.01

\*  $p < .05$ 

<sup>a</sup> where  
 HG = Homogeneous Gifted Group  
 MG = Mixed Gifted (i.e., one gifted and two non-gifted children)  
 MN = Mixed Non-gifted (i.e., two non-gifted with one gifted child)  
 HN = Homogeneous Non-gifted

## CHAPTER 5: Results for the Dyadic Measures

This chapter presents results of the effects of cooperative learning on the peer relations of students participating in the heterogeneous and homogeneous learning groups. All students were asked what they thought of the other students in their group using the *Student Attitudes Questionnaire (SAQ)*. Seven *SAQ* questions were administered prior to and following the treatment, namely, Friendly, Teammate, Smart, Like, Leader, Play, and Shy. One question, concerning how well the student knew the other students in his/her group, was asked only on the pretest and three questions (Another Team, Rater Help, and Target Help) were asked only on the posttest. A copy of the questionnaire is included in Appendix C. The reader should note that the Shy question was reversed, so a larger score means that the target is seen as "Not Shy."

### Basic Model and Statistics

The *SAQ* ratings are dyadic in nature, which means that each rating refers to two different people: the person doing the rating, the perceiver, and the person being rated, the target. In any group, a perceiver rated two targets. Because there were three people in a group, there are a total of six (three perceivers by two targets) ratings in a group, forming what is called a round-robin structure (Kenny, 1990). As was explained in Chapter 3, if any of these ratings is missing, the entire group was eliminated from the analysis. As was also explained in Chapter 3, there are five parameters in the model for the dyadic data. These five parameters are illustrated for the liking measure:

Constant:	How much do the children <i>like</i> each other?
Perceiver:	Do gifted children <i>like</i> other children more than non-gifted children?
Target:	Are gifted children <i>liked</i> more than non-gifted children?
Similarity:	When the children are similar (both gifted or both non-gifted), do they <i>like</i> each other more than when they are different (one gifted and one non-gifted)?
Relativity:	Is a non-gifted child <i>liked</i> more by a non-gifted child when he or she is rated in a homogeneous versus a heterogeneous group?

Table 5.1 contains the basic statistics. We present the means on the measures for the homogeneous non-gifted children because these are most representative of a typical group of children from the classroom. The standard deviations are the relationship standard deviation for those same children. That is, perceiver (how the child sees others) and target effects (how the child is seen by others) have been removed. The pretreatment standard deviations will be used as the denominator to compute effect sizes for pretreatment and change, and the posttreatment standard deviations will be used for the posttreatment. Since effect coding is used for all effects except the constant, the estimated effect sizes must be doubled and then divided by the standard deviation to compute an effect size. It should be noted at this point that the posttest means are lower than the pretest means for all seven variables for which pretest and posttest data were available.

### Pretreatment Ratings

Table 5.2 presents pretreatment means for five groups of children: (1) MGG is the mean for gifted students rating other gifted students in their groups, (2) MGN is the mean for gifted rating non-gifted in their groups, (3) MNG is the mean for non-gifted rating

gifted students in their groups, (4) MNNH is the mean of non-gifted students rating other non-gifted in a homogeneous groups, and (5) MNNM is the mean of non-gifted students rating non-gifted students in a mixed or heterogeneous groups. Recall that *SAQ* ratings are on a four point scale. These means serve as input for the estimates of the model.

The model parameters are presented in Table 5.3. Examining first the constant, we see that the ratings are fairly positive, with only Play being below the scale midpoint of 2.5. There is variability in the rating as is indicated by the relationship standard deviations. And the ratings are certainly not at the ceiling of 4.0. The perceiver effects measure the tendency of gifted children to view others favorably. For many of the variables, the effect is positive, meaning that gifted children view others somewhat more positively than non-gifted children. In fact, for Friendly this effect is marginally significant. Interestingly, for leadership the effect is negative and statistically significant. So for Leader, gifted children see others as not being leaders ( $ES = -.22$ ).

Table 5.1

Mean Rating of the SAQ Scales and Relationship Standard Deviations

<u>Variable</u>	<u>Mean</u>	<u>Standard Deviation</u>
Pretreatment		
Know	3.30	.47
Friendly	2.91	.62
Teammate	3.06	.55
Smart	2.84	.52
Like	2.57	.55
Leader	2.62	.65
Play	2.32	.66
Not Shy	1.69	.67
Posttreatment		
Friendly	2.78	.63
Teammate	2.84	.75
Smart	2.78	.51
Like	2.44	.63
Leader	2.47	.71
Play	2.28	.64
Not Shy	1.64	.70
Another Group	2.30	.84
Target Help	2.85	.73
Rater Help	3.09	.51

Table 5.2

Pretreatment Mean Scores for the *Student Attitudes Questionnaire*

<u>Variable</u>	<u>MGG</u>	<u>MGN</u>	<u>MNG</u>	<u>MNNH</u>	<u>MNNM</u>
Know	3.355	3.264	3.305	3.351	3.245
Friendly	3.108	2.942	2.881	2.934	2.892
Teammate	3.279	3.044	3.224	3.093	3.038
Smart	3.285	2.666	3.121	2.810	2.812
Like	2.647	2.476	2.540	2.576	2.499
Leader	2.875	2.400	2.866	2.637	2.746
Play	2.287	2.247	2.276	2.339	2.225
Not Shy	3.407	3.417	3.390	3.313	3.212

Table 5.3

Effect Estimates for Pretreatment *Student Attitudes Questionnaire*

<u>Variable</u>	<u>Constant</u>	<u>Perceiver</u>	<u>Target</u>	<u>Similarity</u>	<u>Relativity</u>
Know	3.32	.004	.024	.021	.106
Friendly	2.95	.064 <sup>+</sup>	.034	.050	.042
Teammate	3.15	.009	.098*	.019	.055
Smart	2.97	.002	.230*	.079*	.016
Like	2.56	.011	.043	.042	.076
Leader	2.71	-.071*	.163*	.075 <sup>+</sup>	-.109
Play	2.29	-.006	.008	.012	.114
Not Shy	3.37	.042	.030	-.035	.100

\* p &lt; .05

<sup>+</sup> p < .10



The strongest effects in Table 5.3 are Target effects. Gifted children are viewed more favorably on all of the variables. The difference is significant for Smart ( $ES = .89$ ), Leader ( $ES = .50$ ), and Teammate ( $ES = .35$ ). Perhaps it is not very surprising that gifted children are seen as smarter by non-gifted children, after all they score on average about 45 percentile points higher than them on standardized achievement tests. However, children want gifted members in their group and expect them to take on a leadership role.

It is important that the effect for Know is not significant. Thus, gifted children did not report knowing each other any more than non-gifted children. If friendship patterns were determined by ability similarity, then the homogeneous groups would differ in a systematic fashion from the heterogeneous groups.

The similarity effects are, with only one exception, positive. This means that children rate other children who are similar in giftedness more favorably. The only effect that reaches conventional levels of statistical significance is Smart. Children see those who are similar to them as relatively smarter ( $ES = .30$ ). Perhaps children who are similar in giftedness are more likely to be in the same reading group and there is a tendency to inflate the perception of giftedness of group members.

None of the relativity effects are statistically significant at pretreatment. As might be expected, non-gifted children view each other pretty much the same in both homogeneous and heterogeneous groups.

### Posttreatment Ratings

Table 5.4 presents the posttreatment means for the five target groups of ratings. Again, it is important to note that the means at posttreatment are lower than what they are at pretreatment. We will return to this finding when we discuss change score measures. There were three measures that were administered only at the posttest. They are the willingness to be in another group with the target (Another Group), the extent to which the rater helped the target (Rater Help), and the extent to which the target helped the rater (Target Help).

Table 5.5 presents the effect estimates for the posttreatment measures. As with the pretreatment measures, gifted children do not differ much from non-gifted children in their perception of others. The perceiver effects tend to be positive, but they are weak. There is one marginally significant trend that gifted children say they want to play with others more than non-gifted children ( $ES = .27$ ).

The target effects that were significant at the pretest, remain so at the posttest. Gifted children are seen as better teammates, smarter and as leaders more than non-gifted children. Additionally, they are seen as more friendly than non-gifted children ( $ES = .35$ ), and there is a marginally significant difference in liking ( $ES = .25$ ). Gifted children are liked more than non-gifted children.

Gifted children are also seen as giving more help than non-gifted children ( $ES = .49$ ). Interestingly, if we reexamine the perceiver effect, gifted children did not say that they gave any more help than non-gifted children. So others see them as giving help, but they do not see themselves as giving help.

Table 5.4

Posttreatment Mean Scores for the *Student Attitudes Questionnaire*

<u>Variable</u>	<u>MGG</u>	<u>MGN</u>	<u>MNG</u>	<u>MNNH</u>	<u>MNNM</u>
Friendly	2.986	2.631	2.831	2.798	2.674
Teammate	3.088	2.817	2.964	2.872	2.717
Smart	3.205	2.613	3.065	2.786	2.586
Like	2.530	2.295	2.483	2.446	2.359
Leader	2.732	2.343	2.669	2.504	2.302
Play	2.417	2.333	2.148	2.323	2.198
Not Shy	3.385	3.371	3.526	3.359	3.383
Another Group	2.507	2.362	2.474	2.344	2.360
Target Helped	3.128	2.741	3.055	2.891	2.570
Rater Help	3.160	3.057	3.033	3.108	2.879

Table 5.5

Effect Estimates for the Posttreatment *Student Attitudes Questionnaire*

<u>Variable</u>	<u>Constant</u>	<u>Perceiver</u>	<u>Target</u>	<u>Similarity</u>	<u>Relativity</u>
Friendly	2.80	.012	.112*	.065	.125
Teammate	2.93	.037	.110*	.025	.155
Smart	2.89	.017	.243*	.053	.200*
Like	2.43	-.015	.079+	.039	.087
Leader	2.54	.001	.164*	.031	.202+
Play	2.30	.085+	-.007	.049	.126
Not Shy	3.42	-.035	.042	-.035	-.024
Another Group	2.43	.011	.067	.006	-.017
Target Help	2.92	.021	.178*	.016	.321*
Rater Help	3.05	.047	.036	.016	.229*

\* p &lt; .05

+ p &lt; .10

It is also interesting that although gifted children are seen as desirable teammates, children do not necessarily want to be in another group with them. It seems that this decision is guided more by affective than task considerations.

There were no effects of similarity at the posttreatment. So the effects that were present at the pretreatment no longer remained at the posttreatment.

There were four effects for relativity, none of which were present at the pretreatment. Relativity refers to the perceptions of non-gifted children of each other in the homogeneous and the heterogeneous groups. All the effects are positive and so non-gifted children viewed each other more positively in the homogeneous groups than in the heterogeneous groups. They saw each other as smarter (ES = .78), as leaders (ES = .57), and as giving (ES = .89) and receiving more help (ES = .90). Because these effects are considerable in size, the perceptions that non-gifted children have of each other is much lower when they are in heterogeneous groups.

### Change Scores

The means for the changes are presented in Table 5.6. They clearly show a decline over time. These declines are tested by the constant term in the model. The largest effects are the constant. On five of the seven measures, children have much less positive views of their peers after the group experience. The effect sizes are considerable: -.53 for Friendly, -.31 for Smart, -.85 for Teammate, -.45 for Like, and -.46 for Leader. Recall that .5 is considered a moderate effect size.

Although there is a general decline in the perception of the peers, it is less pronounced for gifted children as perceivers. For Leader and Play gifted children have a marginally significant positive view of others. However, for Friendly and Not Shy their views become somewhat more negative.

Table 5.6

#### Change Score Means

<u>Variable</u>	MGG	MGN	MNG	MNNH	MNNM
Friendly	-.123	-.311	-.050	-.134	-.218
Teammate	-.191	-.228	-.259	-.221	-.321
Smart	-.080	-.053	-.056	-.042	-.226
Like	-.117	-.181	-.057	-.130	-.141
Leader	-.144	-.057	-.198	-.133	-.444
Play	.130	.085	-.129	-.016	-.028
Not Shy	-.022	-.045	.133	.046	.171

Table 5.7

Effect Estimates for the Changes in *Student Attitudes Questionnaire*

<u>Variable</u>	<u>Constant</u>	<u>Perceiver</u>	<u>Target</u>	<u>Similarity</u>	<u>Relativity</u>
Friendly	-.165*	-.052+	.079*	.015	.083
Teammate	-.237*	.028	.012	.006	.099
Smart	-.081*	.014	.012	-.026	.184*
Like	-.123*	-.026	.035	-.003	.011
Leader	-.172*	.071+	.001	-.044	.311*
Play	.016	.091+	-.015	.038	.011
Not Shy	.044	-.077+	.012	-.000	-.124

\* p &lt; .05

+ p &lt; .10

Only one target effect is statistically significant. Gifted children are seen as more friendly (ES = .26) than non-gifted children. Recall that Leader, Smart, and Teammate showed large effects pretreatment. Because there are not changes in these variables, the large differences favoring gifted children remained at posttreatment.

Relativity effects showed up in two of the measures. Non-gifted children had much less positive views of each other's smartness (ES = .36) and leadership (ES = .48). The presence of a gifted child in the group significantly lowers the perceptions of gifted children of each other.

## Conclusion

Gifted children are favorably viewed by their peers before the groups are formed and afterwards. Although there are indications that gifted children are seen as more friendly than non-gifted children and that they are liked somewhat more, the differences in perceptions appear to be linked to the task. That is, gifted children are seen as smarter, as more likely to be leaders, and as more desirable teammates.

The second major effect is that non-gifted children views of each other are much less favorable when they are in heterogeneous groups than when they are in homogeneous groups. Because the only difference in these two groups is the presence of a gifted child in the heterogeneous group, it must be that non-gifted children suffered in their ratings by non-gifted children because of comparisons to the gifted child. We know that the gifted child appeared to help more and appeared to be a leader. Non-gifted children just appeared to be less skilled in these groups.

It may seem as if only non-gifted children are "discriminating against each other." However, gifted children were only in one type of group with non-gifted children (i.e., one gifted and two non-gifted children) whereas non-gifted children were in two types of

groups. If we had a group with two gifted children and one non-gifted child, we might have found gifted students in such a group viewing each other favorably.

The third major effect is the decline in perceptions over time. Children have significantly less favorable impressions of each other at the posttreatment. As with any over-time comparison, there are a number of possible explanations as to the decline: history, maturation, and instrumentation. History does not seem plausible, especially since the result is replicated in some 35 classrooms at many different schools. Maturation is not viable in that the children are only about three weeks older. The most plausible alternative explanation is instrumentation.

Research evidence has shown that children often have unrealistic expectations about group interactions. Moreover, children, more than most adults, are prone to negative and hostile interactions. Thus, the children may have been surprised by the conflict that they encountered in the groups.

The peer perception data provide considerable insights to what happened in the groups. In the last chapter of this report, we will tie together all of our results and elaborate their policy implications.

## CHAPTER 6: Summary, Discussion, and Conclusions

The study described in this report was a controlled field experiment designed to assess the effects of cooperative learning on gifted and non-gifted students receiving instruction in homogeneous and heterogeneous ability groups. Although research has found that students generally learn more and have more positive impressions of themselves and other group members after involvement in heterogeneously formed cooperative groups (e.g., Johnson et al., 1983; Slavin, 1990b, 1991c), little research has been conducted on the effects of such cooperative learning arrangements on gifted students (Robinson, 1991). Because of this, a number of observers (e.g., Robinson, 1991; Rogers, 1991) have suggested that the widespread adoption of cooperative learning with gifted students is unwarranted and potentially harmful. The present research was undertaken to provide researchers, administrators, and teachers with tangible evidence as to the effectiveness of cooperative learning with gifted students. It was also undertaken to provide additional evidence about the effects of cooperative learning on non-gifted students.

The study investigated the effects of cooperative learning on gifted and non-gifted students' achievement, attitudes toward self and school, and perception of others. A total of 786 fourth grade students from 42 classrooms located in 8 school districts participated in the research. These students were organized into three different types of three-person groups: a gifted homogeneous group, a non-gifted homogeneous group, and a heterogeneous group. All 262 of these groups worked on two types of cooperative learning tasks, a worksheet-oriented math task and a higher-level science task. For each of these tasks students participated in nearly four one-hour learning sessions in the regular classroom environment. Three measurement periods were used in the study: the first occurred immediately after group assignment and prior to any group interaction; the second occurred after the first series of learning sessions; and the third occurred after the second series of learning experiences. During measurement period one, students completed a peer rating, a self-concept measure, and a school subjects attitude scale. Measurement periods two and three repeated the measures taken during period one, but also involved the evaluation of task-specific achievement.

### Review of Major Findings

As noted above, this study investigated the effects of cooperative learning strategies implemented in homogeneous and heterogeneous ability groups on gifted and non-gifted students' achievement, self-concept, attitudes toward school subjects, and perceptions of peers. The major findings for each of these outcome measures are as follows:

#### *Achievement*

1. The achievement of gifted students exceeded that of non-gifted students in both mathematics and science regardless of the type of group in which they were involved, but this difference can be entirely explained by gifted students' higher prior achievement.
2. Gifted students worked at a quicker pace and produced more when grouped with other gifted students. Said in another way, the productivity level of the group is directly tied to the number of gifted students in the group.
3. However, gifted students learned about the same (i.e., had the same levels of posttest achievement) in homogeneous gifted groups as they did in heterogeneous groups.
4. Non-gifted students learned the same in homogeneous and heterogeneous groups.

5. Having a gifted student in a group does not significantly improve the performance of others in the group.

#### *Self-concept*

6. Gifted students saw themselves as smarter than their non-gifted peers prior to the treatment (i.e., their academic self-esteem is higher).
7. Gifted students had a higher perception of their worth as a person (global self-esteem) than non-gifted students prior to the treatment.
8. Gifted and non-gifted students' social self-esteem did not differ prior to the treatment.
9. Both the gifted and non-gifted students' social self-esteem declined when they were in a group with another gifted student.
10. Academic self-esteem improved for both gifted and non-gifted students, but more for non-gifted students.
11. Neither gifted nor non-gifted students' global self-esteem was affected by the cooperative learning arrangement.
12. There were no differences in the three self-esteem measures (i.e., global, social, and academic) for heterogeneously grouped gifted students versus homogeneously group students.

#### *Attitude Toward School Subjects*

13. The different grouping strategies have no significant effect on the attitudes toward mathematics and science of either gifted or non-gifted students.

#### *Perception of Peers*

14. Gifted students are perceived by their peers as more intelligent, better teammates, and as more likely to leaders than non-gifted students. The relatively favorable impressions of the gifted students remained after the grouping experience.
15. At the end of the study, gifted and non-gifted students had more negative impressions of each other than they had before the treatment began.
16. Gifted students were perceived by their peers as providing more help than non-gifted students to other members of the cooperative learning groups.
17. Non-gifted students had more negative perceptions of each other when they were in heterogeneous groups than when they were in homogeneous groups.

We turn now to a discussion of these findings.

## **Achievement Findings**

For the achievement data, we had expected that gifted students would outperform non-gifted students in both mathematics and science regardless of the type of group in which they were involved, and they did. This effect, which we have called the actor effect, vanished when prior achievement was accounted for. This means that in general gifted students did not learn any more from their mathematics and sciences experiences than non-gifted students when their scores were equated on the basis of a standardized test.

We had also expected that the composition of the group in which the student received instruction would interact with the type of task to produce different partner (the effect of having a gifted partner) and grouping (the advantage of being in a homogeneous group) effects for mathematics and science. For the mathematics task, we expected that having an individual in a group who would likely know the correct answer (the gifted

student) would help the other group members do well. We had also speculated that heterogeneous groups would outperform the average of homogeneous groups.

For the science task, which was a higher-level learning task than the mathematics task, we had expected that gifted students would use different learning strategies from non-gifted students and that these strategies would lead to learning losses when gifted and non-gifted students worked together. Consequently, we expected that homogeneous groups would outperform heterogeneous groups, a grouping effect. However, we expected no partner effect for the science task, that is, there should be no direct effect on science achievement because someone has a gifted student in his or her group.

Contrary to our expectations, none of the partner or grouping effects for either mathematics or science was statistically significant. There was an indication that having gifted students in cooperative mathematics groups was of some benefit to all other students in their group, but this was only a trend and not worthy of further comment. Taken together, then, our partner and grouping results suggest that having a gifted student in a group does not help or hinder other group members' academic performance.

It should be noted, however, that for the mathematics task gifted students worked at a quicker pace and produced more (i.e., completed more worksheets) when grouped with other gifted students. In fact, gifted students grouped homogeneously produced more than students in heterogeneous groups, who in turn produced more than homogeneously grouped non-gifted students.

Two other issues must be considered in interpreting these achievement results. First, Kulik (1992) reports that students perform better in ability groups when the curriculum content appropriately matches the students' ability level. The mathematics and science curricula used in the present study were not adjusted to the ability levels of the various heterogeneous and homogeneous groups. On the contrary, the same set of curriculum materials were used with all types of students. Perhaps different results would have been found if curriculum adjustments had been made. Second, it is possible that the length of the intervention may have affected the results. In this study each intervention (mathematics and science) was approximately three and one-half class sessions in duration. Perhaps, as suggested by Slavin (1990b), longer interventions would have produced different results because students would have had more time to work with the curriculum and each other.

### **Self-Concept Findings**

Gifted students were found to have higher academic and global self-esteem than their non-gifted peers prior to the cooperative learning intervention. However, the social self-esteem of these untreated groups of students was found to be comparable. These expected results are consistent with those reported by Hoge and Renzulli (1991) in their comprehensive review of the literature.

With regard to treatment effects, one of the more interesting, and unexpected, findings of this study was that in general students' academic self-concepts increased as a result of the cooperative learning experience. That is, at the end of the Two-week intervention students on average showed significant increases in how they viewed their academic abilities. This finding supports the work of Johnson and Johnson (1983), Slavin (1991c) and others who argue that cooperative learning leads students to have more



positive self-concepts. We should note again, though, that the global and social self-concepts of children did not change.

The main focus of this study, however, was not how cooperative learning affects students in general, but rather how the composition of the group and the presence of gifted students in the group affect group members. It appears that whether students are in homogeneous or heterogeneous groups has no effect on the global, academic, and social self-concepts of students. This finding provides some support for research showing that gifted programs (that is, homogeneous gifted groups) do not affect students' self-concepts (Karnes & Wherry, 1981; Kolloff & Feldhusen, 1984; Maddux, Scheiber, & Bass, 1982). The finding also suggests that varying the composition of cooperative learning groups may not have a significant effect on how students view themselves. However, looking at the effect that gifted students have on other students, the conclusions are much different.

When a gifted student interacts with other students, it appears that students experience a significant decrease in social self-concept. That is, students who interact with gifted students see themselves as having fewer friends and as being liked less by their peers. The reasons for this decline may be that gifted students are seen as more competent and more friendly than non-gifted students, as discussed below. Because gifted students are perceived more positively on task-oriented skills, students may in general feel less socially competent in comparison to the gifted student.

Interestingly, however, students did not experience a significant decline in either academic or global self-concept when interacting with gifted students. One would expect that if students did use the most gifted member of the group as a social context reference point, those who interacted with gifted students would experience a decline in their academic self-concept (Marsh, 1990), but this was not the case.

Why don't gifted students have a negative effect on the academic self-concepts of other students, as Marsh (1990) argues they should? Perhaps gifted students were not used as a comparison other by non-gifted students. The interpersonal rating data show that students perceived that gifted students were very smart both before and after group interaction. It may be that on an academic dimension gifted students are too dissimilar to other students in general to serve as comparison others. Consequently, the non-gifted students do not experience a negative change in self-concept when interacting with gifted students because non-gifted students do not compare their academic ability with that of gifted students.

### **Interpersonal Perceptions Findings**

One proposed benefit of cooperative learning is improved social relations of group members (Cotton & Cook, 1982; Johnson et al., 1983). This study attempted to address the specific effects that different types of grouping arrangements in a cooperative learning context have on this outcome. This discussion of our interpersonal perception findings is subdivided into five subsections. First, the students' perceptions of each other prior to interaction are discussed. Then the change in perceptions after the cooperative learning experience is discussed for the following issues: (a) how the perceptions of all students changed; (b) how other students' views of gifted students changed; and (c) how non-gifted students views of other non-gifted students changed after the group interaction. Finally, the overall pattern of findings for the interpersonal perceptions results is discussed.

### **Perceptions Prior to Interaction**

Do students perceive gifted students differently from non-gifted students? That is, before the groups interact, do students share similar perceptions regarding their fellow classmates? We found that gifted students are more likely to be seen as a better leader, a better teammate, and as smarter than non-gifted students. However, gifted children, as compared to non-gifted children, are not seen as any more or less a friend, as someone who is known more or less by others, or as someone who is liked more or less than others. We also discovered a trend for students who are similar to one another in giftedness to see each other as more leader-like and smarter than those individuals who are dissimilar with respect to giftedness.

The present findings suggest that students share perceptions about their teammates on task-related or classroom-related measures, but not socioemotional measures. This agreement about classroom-related activities (e.g., teammate, leader, and smart) and the lack of agreement on socioemotional measures (e.g., friendly, liking, or shy) may be due in part to how easily students can observe the traits being measured. For example, all students in a classroom most likely have a greater opportunity to view fellow students participating in classroom activities than nonclassroom-related behaviors. This increased opportunity combined with gifted students being more likely to excel in classroom activities could explain why students agree that gifted students are higher in classroom skills than non-gifted students.

### **How Group Members' Perceptions of All Students Changed After Interaction**

One of the more striking findings of our research is that overall students perceived each other to be less friendly, less of a teammate, less smart, less likable, and less of a leader after interaction in cooperative learning groups. That is, unrelated to ability, students in the homogeneous gifted, homogeneous non-gifted, and heterogeneous groups had more negative perceptions of group members as a result of the group experience. This result supports the work of Bales and his colleagues who reported that in groups of children most of the activity involves negative socioemotional behaviors (Brown, 1988, p. 37). If the goal of cooperative learning is to improve the relations among students, this overall negative effect on perceptions should give us concern.

Yet, these findings are in direct contrast to earlier findings from cooperative learning studies (Cotton & Cook, 1982; Slavin, 1990b). What are some possible reasons for these negative effects? One important reason may be the role that intergroup competition and intragroup cooperation play in the group process. Intergroup competition may be a binding mechanism that generates positive attitudes towards the group members. In fact, many models of cooperative learning rely heavily upon intergroup competition. Because competition among groups was not present in our study, the intragroup relationships may become more negative (Vinacke, 1963).

### **Changes in How Group Members Perceived Gifted Students After Interaction**

Earlier, it was stated that students shared expectations that gifted students were smarter, better leaders, and better teammates than non-gifted students, but that there were no differences in how gifted and non-gifted students were perceived on socioemotional dimensions. Does this shared view change after interaction in cooperative learning groups? Student expectations about gifted students' task-related ability did not change as a result of the cooperative learning experience. More precisely, gifted students were not seen by other

students any more positively or negatively on these task-related dimensions after interaction than they were prior to interaction. Interestingly, after the group experience gifted students were seen as more friendly, relative to non-gifted students, than they were seen prior to group interaction. It appears that even though non-gifted and gifted students were seen as equally friendly prior to interaction, students generally believe that gifted students are friendlier after they interact with them.

Why would there be no differences in how friendly gifted and non-gifted students are perceived to be prior to interaction, but differences favoring gifted students following interaction? One possible explanation is that gifted students provided more help to other students than non-gifted students did, and that this help was seen as a friendly act by the recipients. The finding also provides some support for the argument that members of cooperative groups tend to help each other. However, it is important to reiterate that even though gifted students helped their group members, there were no partner effects for the achievement measures. That is, while gifted students are being helpful, this help does not improve student learning. Perhaps such help would be efficacious among older children, in which case partner effects would be found.

### **Changes in How Non-Gifted Group Members Perceived Other Non-Gifted Students After Interaction**

It was proposed that the social context of the cooperative group plays an important role in how students see themselves and others. If the social context affects how students see one another, this effect would be most pronounced when comparing how non-gifted students saw other non-gifted students in the presence versus the absence of the gifted students. Based on the social context of the group, it was predicted that non-gifted students should be seen more negatively after group interaction when in a heterogeneous group, but not when they are in a homogeneous group.

Prior to interaction there were no differences in how non-gifted students rated other non-gifted students in homogeneous as compared to heterogeneous groups for all the interpersonal variables measured. That is, before the group process there were no differences in how non-gifted students saw each other. However, there were differences in how non-gifted children were seen by their peers in heterogeneous as opposed to homogeneous groups after interaction.

After the group interaction, non-gifted students in heterogeneous groups saw each other as being less competent on task-relevant dimensions relative to how non-gifted students saw each other in homogeneous groups. First, with regard to helping teammates, non-gifted students in heterogeneous groups perceived that they help their fellow non-gifted students significantly less than do non-gifted students in homogeneous groups. Also, non-gifted students perceived their non-gifted group members as less helpful in heterogeneous groups as opposed to homogeneous groups. In addition to non-gifted students being seen as less helpful by other non-gifted students in heterogeneous groups, the non-gifted student is seen as less competent on other task-relevant dimensions in heterogeneous groups. Non-gifted students are seen as being smarter and as more of a leader by their non-gifted peers in homogeneous as opposed to heterogeneous groups.

Apparently, the presence of a gifted student in a group affects how non-gifted students see each other on task-relevant dimensions. These findings would suggest that the social context of the group does affect the perceptions of the group member. Gifted students in general are seen as more competent on task-relevant skills. When non-gifted students judge other non-gifted students in the presence of someone who is high on task-

relevant dimensions, non-gifted students are seen as being less competent at these task-related skills.

### **The Picture of Interpersonal Perceptions in the Groups**

Two predominant results emerged in this study. First, students tend to have much more negative views of each other after the cooperative learning experience. This overall de-evaluation of group members is not a function of the ability composition of the group. In addition, students devalue each other on both socioemotional and task-related dimensions.

Second, the majority of the effects related to the presence of a gifted student predominately occur for task-related dimensions. For instance, students have expectations that gifted students are leaders, smart, and good teammates prior to interacting in the group, but gifted students are not seen as being different from non-gifted students on socioemotional variables such as friendly or likable. These perceptions do not change after the group interacts on the task (with the exception of the perception of friendly).

In addition to how gifted students are seen by others, the presence of a gifted student changed how non-gifted students saw one another. When non-gifted students were in a group with gifted students, non-gifted students saw each other as being less competent at task-related dimensions, such as intelligence and leadership, than non-gifted group members saw each other in homogeneous groups. However, there were no differences for the socioemotional dimensions.

What can one expect to occur to social relationships in cooperative groups? First, most of the changes in perceptions were for task-related dimensions, not socioemotional dimensions. In general, large changes in the socioemotional relationships among students should not be expected. The types of changes in the social relations of group members may depend upon the tasks and outcomes of the groups. If the goal of the group is to complete academic material, most of the changes in perceptions may be task-related (perceptions of leadership and helping behaviors), and no changes in socioemotional changes may occur (perceptions of friendliness and liking). If behaviors which promote liking and friendliness were tied to the task, then perhaps there might be changes in socioemotional outcomes.

Second, gifted students do indeed help other students in general, and this help is not necessarily threatening to the other students in the group (gifted students were seen as more friendly at the end of the study). This helping effect is independent of group composition. That is, gifted students are seen as more helpful in both homogeneous and heterogeneous groups. Third, when students are grouped heterogeneously with a gifted student, perceptions among non-gifted students work with a gifted partner compared to non-gifted students working in homogeneous groups, the non-gifted students will see each other as less smart, less of a leader, and less helpful.

### **Limitations of the Current Study**

Several features of this study could explain the lack of significant findings for the achievement outcomes. If the treatment period had been longer, more statistically significant effects may have been found. In fact, Slavin (1990b) suggests that treatment should last at least four weeks (20 hours). However, as noted above, given the costs, the

scope of the study and the commitment required of the districts, we were able to introduce the treatment for only 7 1/2 hours.

This study also avoided any intergroup competition which most models of cooperative learning advocate. Although it is presumed that intergroup competition improves student achievement, intergroup competition was avoided in the present study because of the concern that a homogeneous gifted group would do better than all other groups, and this could have had a negative effect on all students in the classroom. Because most current cooperative learning models structure groups heterogeneously, this concern would not be a problem in most settings. However, teachers should be cautious if combining intergroup competition with homogeneous groups.

Some caution is also warranted when interpreting change score constant effects, specifically, the interpersonal change score and self-concept change score constant effects. It is possible that the changes in the constant from pretest to posttest could be due to experimental artifacts. Because this study does not compare the overall mean change of students' scores with the overall mean of a control group, it may be that the academic self-concept increases and the interpersonal perception declines are due to a testing effect, history effect, or other experimental artifact. More specifically, uncontrolled systematic factors could affect the constant change score.

Finally, several features of the study limit the generalizability of the results. First, the racial/ethnic composition of the study sample (approximately 87% White) limits the degree to which these results can be generalized to all students in the United States. Second, the tasks used in this study were specifically designed for the purposes of this research. That is, they were designed with specific time limits in mind and to promote group interaction. Thus, the nature of the curriculum also limits the generalizability of the findings. Third, the children involved in this research may be too young to be able to successfully help one another. If so, the results of this study may not be generalizable to older, more capable children.

## Conclusion

How do students with different academic abilities affect other students in cooperative learning groups? Our research suggests that heterogeneous and homogeneous ability grouping in comparative learning contexts has no appreciable effects on students' academic outcomes. It also suggests that having a high ability student in a group does not help other students to learn more. Gifted students are perceived by other group members to be more helpful than non-gifted students. However, if gifted students are helping students, this help does not translate into greater academic gains for the gifted students' teammates.

If grouping does not affect the academic outcomes of students, choices regarding how to group students should be based on considerations other than improving academic growth. If the goal of grouping is promoting students' sense of self-worth, then teachers should realize that mixed ability grouping can have a negative effect on average ability students' self-concept. Even though we found few changes in student self-concept that could be attributed to the composition of the groups, when any student works with a gifted student, the social self-concept of the gifted student's teammates declines.

Another reason for grouping students is to have students learn to cooperate with each other and in turn improve the social relationships among students, that is, have students "learn to get along." The current findings suggest that the group interaction

process may not achieve this goal. In fact, we found that overall students' interpersonal perceptions were more negative following group interaction. We also found that gifted students affect non-gifted students' perceptions of each other. In the presence of a gifted student, non-gifted students perceive that their non-gifted peers are not as smart, less helpful, and less likely to be a leader than if there is no gifted student in the group. Thus, if cooperative learning with heterogeneous grouping is to occur, teachers will need to explain to children that some children will need to help other children more and that if they do they are just doing their job.

It appears that the majority of changes in the interpersonal perceptions involved traits related to classroom behaviors. It seems that the group experience led to agreement that some members were skilled in dimensions more closely associated with classroom activities, e.g., leadership, teammate, and smart. However, there was no agreement on dimensions related to socioemotional dimensions, such as friendliness and liking. It may be that in academic-oriented tasks students do not have the opportunity to display behavior related to socioemotional dimensions. To promote friendship and liking in a group may require group tasks to be less academically oriented, and more oriented towards promoting friendship.

This study has proposed interesting and meaningful ways to look at data from groups. It has provided a method to estimate how much individuals with differing abilities contribute to another person's academic performance, view of self, and a person's view of others. Many possibilities remain to be investigated. For example, what is the impact of a lengthier intervention? What would occur if groups were intragroup homogeneous, intergroup heterogeneous, and there was intergroup competition? Is it a label of giftedness or merely prior success at academic projects which leads to differences in perceptions of the self and others?

## Summary

This study has answered an important question: what happens to gifted and non-gifted students when they interact together in cooperative learning groups? Gifted fourth grade students experienced no adverse effects as a result of interacting with non-gifted students in cooperative learning groups. The gifted student does not learn less, experience a decline in self-concept, or become less popular in his or her group. In fact, gifted students are seen as more friendly and better leaders in these groups, and they experience a relative increase in social self-esteem.

At the same time, the non-gifted student does not experience an increase in achievement due to the presence of a gifted student. Thus, the view of the gifted student as a teaching resource was not supported. However, the non-gifted student in heterogeneous groups suffers from a decline in self-esteem and a decline in the perception by non-gifted peers on task-relevant activities declines. In sum, heterogeneous grouping has positive socioemotional outcomes for gifted students and negative ones for non-gifted students.

The view that the gifted student serves as a resource does receive some support in this study. Gifted students were seen as providing help and leadership in groups. However, this did not translate into greater learning for the gifted student's peers. A related finding is that virtually none of the variance in the science test and only 10% of the mathematics test was due to group. At least for students of this age and with this curriculum, the performance of a student was not linked to the performance of the student's fellow group members. This occurred despite our extensive efforts to make the task a

group task and to minimize assistance from the experimenter and the classroom teacher. Students worked in "groups" but they learned as individuals.

Finally, claims that homogeneous grouping of gifted students leads to synergetic benefits for these students was not supported. There is no evidence in this study that grouping gifted students homogeneously in cooperative groups is any more beneficial educationally than heterogeneous grouping. However, because the curriculum was not modified for these groups, we do not know how they would have performed with a more accelerated curriculum.

## References

- Adams, H. B., & Wallace, B. (1988). The assessment and development of potential of high school pupils in the third world context of Kwa-Zulu/Natal. *Gifted Education International*, 5(3), 132-137.
- Allen, W. H., & Van Sickle, R. L. (1984). Learning teams and low achievers. *Social Education*, 48, 60-64.
- Aronson, E., Blaney, N., Stephan, C., Sikes, J., & Snap, M. (1978). *The jigsaw classroom*. Newbury Park, CA: Sage.
- Augustine, D., Gruber, K., & Hanson, L. (1990). Cooperation works! *Educational Leadership*, 47, 4-7.
- Bartell, N. P., & Reynolds, W. M. (1986). Depression and self-esteem in academically gifted and nongifted children: A comparison study. *Journal of School Psychology*, 24, 55-61.
- Beane, W. E., & Lemke, E. A. (1971). Group variables influencing the transfer of conceptual behavior. *Journal of Educational Research*, 62, 215-218.
- Blaney, N. T., Stephan, S., Rosenfield, D., Aronson, E., & Sikes, J. (1977). Interdependence in the classroom: A field study. *Journal of Educational Psychology*, 69(2), 121-128.
- Brown, R. (1988). *Group process: Dynamics within and between groups*. New York: Basil Blackwell.
- Bryk, A. S., & Radenbush, S. W. (1992). *Hierarchical linear models: Applications and data analysis methods*. Newbury Park, CA: Sage.
- Byrne, B. M., & Shavelson, R. J. (1986). On the structure of adolescent self-concept. *Journal of Educational Psychology*, 78(6), 473-484.
- Campbell, A. L. (1965). A comparison of the effectiveness of two methods of class organization for the teaching of arithmetic in junior high school. *Dissertation Abstracts International*, 26, 813-814. (University Microfilms Order No. 65-06726)
- Chance, E. W., & Chance, P. L. (1987). Applying control theory in the gifted and talented classroom. *Journal of Reality Therapy*, 7(1), 36-41.
- Cignetti, M. J. (1974). A study of intraclass grouping and traditional grouping on students' terminal achievements during the last nine weeks in first semester typewriting. *Dissertation Abstracts International*, 35, 5765A. (University Microfilms No. 75-05121)
- Clifford, K. (1988). Educating the gifted adolescent as co-learner: The Learning Enrichment Service (LES) and the Mentor Academy Program (MAP). *Gifted Education International*, 5(3), 160-169.
- Cohen, J. (1988). *Statistical power analysis for the behavioral sciences* (2nd ed.). Hillsdale, NJ: Lawrence Erlbaum.



Cohen, J., & Cohen, P. (1983). *Applied multiple regression/correlation analysis for the behavioral sciences* (2nd ed.). Hillsdale, NJ: Lawrence Erlbaum.

Coleman, J., & Fults, B. (1982). Self-concept and the gifted classroom: The role of social comparisons. *Gifted Child Quarterly*, 26, 116-120.

Coleman, J., & Fults, B. (1985). Special-class placement, level of intelligence, and the self-concepts of gifted children: A social comparison perspective. *Remedial and Special Education*, 6, 7-12.

Coopersmith, S. (1967). *The antecedents of self-esteem*. San Francisco: Freeman.

Cotton, J. L., & Cook, M. S. (1982). Meta-analyses and the effects of various reward systems: Some different conclusions from Johnson et al. *Psychological Bulletin*, 92, 176-183.

Dean, R. S. (1977). Effects of self-concept on learning with gifted children. *Journal of Educational Research*, 70, 315-318.

Deutsch, M. (1949). An experimental study of the effects of cooperation and competition upon group process. *Human Relations*, 2, 199-232.

De Vries, D., & Edwards, K. (1973). Learning games and student teams: Their effects on classroom process. *American Educational Research Journal*, 10, 307-318.

De Vries, D. L., Edwards, K. J., & Wells, E. H. (1974). *Teams-games-tournament in the social studies classroom: Effects on academic achievement, student attitudes, cognitive beliefs, and classroom climate* (Report No. 173). Baltimore: Johns Hopkins University, Center for Social Organization of Schools.

De Vries, D. L., Lucasse, P. R., & Shackman, S. L. (1980). *Small group vs. individualized instruction: A field test of relative effectiveness* (Report No. 293). Baltimore: Johns Hopkins University, Center for Social Organization of Schools.

De Vries, D. L., Mescon, I. T., & Shackman, S. L. (1975). *Teams-games-tournament (TGT) effects on reading skills in the elementary grades* (Report No. 190). Baltimore: Johns Hopkins University, Center for Social Organization of Schools.

Dewar, J. A. (1963). Grouping for arithmetic instruction in sixth grade. *Elementary School Journal*, 63, 266-269.

Eddleman, V. K. (1971). A comparison of the effectiveness of two methods of class organization for arithmetic instruction in grade five. *Dissertation Abstracts International*, 32, 1744A. (University Microfilms No. 71-25035)

Feldhusen, D. H., Sayler, M. F., Nielsen, M. E., & Kolloff, P. B. (1990). Self-concepts of gifted children in enrichment programs. *Journal for the Education of the Gifted*, 13, 380-387.

Freeman, J. (1985). Emotional aspects of giftedness. In J. Freeman (Ed.), *The psychology of gifted children* (pp. 247-264). New York: Wiley.

Gamoran, A., & Berends, M. (1987). The effects of stratification in secondary schools: Synthesis of survey and ethnographic research. *Review of Educational Research*, 57, 415-435.

Geffner, R. A. (1978). The effects of cooperative and interdependent interactions on the self-esteem, attitudes, interethnic relations, and intraethnic perceptions of elementary school children: A field experiment. *Dissertation Abstracts International*, 39, 3586B. (University Microfilms No. 79-00823)

Gonzales, A. (1979). *Classroom cooperation and ethnic balance*. Paper presented at the annual convention of the American Psychological Association, New York.

Gonzales, A. (1981). *An approach to interdependent/cooperative bilingual education and measures related to social motives*. Unpublished manuscript, California State University at Fresno.

Harter, S. (1985). *Manual for the Self-Perception Profile for Children*. Unpublished manuscript, University of Denver.

Harter, S. (1986). Processes underlying the construction, maintenance, and enhancement of the self-concept in children. In J. Suls & A. G. Greenwald (Eds.), *Psychological Perspectives on the Self* (Vol. 3, pp 139-181). Hillsdale, NJ: Lawrence Erlbaum.

Hoge, R. D., & McSheffrey, R. (1991). An investigation of self-concept in gifted children. *Exceptional Children*, 57, 238-245.

Hoge, R. D., & Renzulli, J. S. (1991). *Self-concept and the gifted child* (RBDM 9104). Storrs, CT: University of Connecticut, The National Research Center on the Gifted and Talented.

Humphreys, B., Johnson, R., & Johnson, D. W. (1982). Effects of cooperative, competitive, and individualistic learning on students' achievement in science class. *Journal of Research in Science Teaching*, 19, 351-356.

Janos, P. M., Fung, H. C., & Robinson, N. M. (1985). Self-concept, self-esteem, and peer relations among gifted children who feel "different." *Gifted Child Quarterly*, 29, 78-82.

Johnson, D. W., & Johnson, R. T. (1981). Effects of cooperative and individualistic learning experiences on interethnic interaction. *Journal of Educational Psychology*, 73, 444-449.

Johnson, D. W., Johnson, R. T., & Holubec, E. (1990). *Circles of learning: Cooperation in the classroom* (3rd ed.). Edina, MN: Interaction Book Company.

Johnson, D. W., Johnson, R. T., & Maruyama, G. (1983). Interdependence and interpersonal attraction among heterogeneous and homogeneous individuals: A theoretical formulation and a meta-analysis of the research. *Review of Research in Education*, 53, 415-424.

Johnson, D. W., Johnson, R. T., Tiffany, M., & Zaidman, B. (1983). Cross-ethnic relationships: The impact of intergroup cooperation and intergroup competition. *Journal of Educational Research*, 78, 75-79.

Johnson, D. W., Maruyama, G., Johnson, R., Nelson, D., & Skon, L. (1981). Effects of cooperative, competitive, or individualistic goal structures on achievement: A meta-analysis. *Psychological Bulletin*, *89*, 47-62.

Johnson, D. W., Skon, L., & Johnson, R. T. (1980). Effects of cooperative, competitive, and individualistic conditions on children's problem-solving performance. *American Educational Research Journal*, *17*, 83-93.

Johnson, R. T., & Johnson, D. W. (1983). Effects of cooperative, competitive, and individualistic learning experiences on social development. *Exceptional Children*, *49*, 323-330.

Johnson, R. T., Johnson, D. W., & Stanne, M. B. (1986). Effects of cooperative, competitive, and individualistic goal structures on computer-assisted instruction. *Journal of Educational Psychology*, *77*, 668-677.

Johnson, R. T., Johnson, D. W., Stanne, M. B., & Garabaldi, A. (1990). Impact of group processing on achievement in cooperative groups. *Journal of Social Psychology*, *130*, 507-516.

Jones, D. M. (1948). An experiment in adaptation to individual differences. *Journal of Educational Psychology*, *39*, 247-272.

Joyce, B. R. (1991). Common misconceptions about cooperative learning and gifted students: Response to Allan. *Educational Leadership*, *48*(6), 72-73.

Judd, C. M., & Kenny, D. A. (1981). *Estimating the effects of social interventions*. Cambridge, England: Cambridge University Press.

Kagan, S. (1985). Co-op Co-op: A flexible cooperative learning technique. In R. E. Slavin, S. Sharan, S. Kagan, R. Hertz-Lazarowitz, C. Webb, & R. Schmuck (Eds.), *Learning to cooperate: Cooperating to learn*. New York: Plenum.

Kanevsky, L. (1985). Computer-based math for gifted students: Comparison of cooperative and competitive strategies. *Journal for the Education of the Gifted*, *8*, 239-255.

Karnes, F. A., & Wherry, J. N. (1981). Self-concepts of gifted students as measured by the Piers-Harris Children's Self-concept Scale. *Psychological Reports*, *49*, 903-906.

Kenny, D. A. (1987). *Statistics for the social and behavioral sciences*. Boston: Little, Brown.

Kenny, D. A. (1990). What makes a relationship special? In T. W. Draper & A. C. Marcos (Eds.), *Family variables: Conceptualization, measurement, and use* (pp. 161-178). Newbury Park, CA: Sage.

Kenny, D. A., Albright, L., Malloy, T. E., & Kashy, D. A. (in press). Consensus and interpersonal perception: Acquaintance and the big five. *Psychological Bulletin*, *116*, 245-258.

Kenny, D. A., & Judd, C. M. (1986). Consequences of violating the independence assumption in analysis of variance. *Psychological Bulletin*, *99*, 422-431.

Kolloff, P. B., & Feldhusen, J. F. (1984). The effects of enrichment on self-concept and creative thinking. *Gifted Child Quarterly*, 28, 53-57.

Kolloff, P. B., & Moore, A. D. (1989). Effects of summer programs on the self-concepts of gifted children. *Journal for the Education of the Gifted*, 12, 268-276.

Kramer, H. C., & Jacklin, C. N. (1979). Statistical analysis of dyadic social-behavior. *Psychological Bulletin*, 86, 217-224.

Kulik, C. L. (1985). *Effects of inter-class ability grouping on achievement and self esteem*. Paper presented at the annual convention of the American Psychological Association. Los Angeles, CA.

Kulik, C. L. C., & Kulik J. A. (1982). Effects of ability grouping on secondary school students: A meta-analysis of evaluation findings. *American Educational Research Journal*, 19, 415-428.

Kulik, C. L. C., & Kulik, J. A. (1984). *Effects of ability grouping on elementary school pupils: A meta-analysis*. Paper presented at the annual meeting of the American Psychological Association, Toronto. (ERIC Document Reproduction Service No. ED 255 329)

Kulik, J. A. (1992). *An analysis of the research on ability grouping: Historical and contemporary approaches* (RBDM 9204). Storrs, CT: University of Connecticut, The National Research Center on the Gifted and Talented.

Kulik, J. A., & Kulik, C. L. C. (1990). Ability grouping and gifted students. In N. Colangelo & G. A. Davis (Eds.), *Handbook of gifted education* (pp. 178-196). Boston: Allyn & Bacon.

Kulik, J. A., & Kulik, C. L. C. (1992). Meta-analytic findings on grouping programs. *Gifted Child Quarterly*, 32, 73-77.

Kulikowich, J. M. (1990). *The Content Area Preference Scale (CAPS)*. Storrs, CT: University of Connecticut, The National Research Center on the Gifted and Talented.

Kulikowich, J. M., Reis, S. M., Owen, S. V., & Smist, J. (in preparation). *The reliability and validity of scores derived from the Content Area Preference Scale (CAPS)*.

Lazarowitz, R., Baird, H., Bowlden, B., & Hertz-Lazarowitz, R. (1982). *Academic achievements, learning environment, and self-esteem of high school students in biology taught in cooperative-investigative small groups*. Unpublished Manuscript, The Technion, Haifa, Israel.

Lucker, G. W., Rosenfield, D., Sikes, J., & Aronson, E. (1976). Performance in the interdependent classroom: A field study. *American Educational Research Journal*, 13, 115-123.

Madden, N., & Slavin, R. (1983). Effects of cooperative learning on the social acceptance of mainstreamed academically handicapped students. *Journal of Special Education*, 17, 171-183.

Maddux, C. D., Scheiber, L. M., & Bass, J. E. (1982). Self-concept and social distance in gifted children. *Gifted Child Quarterly*, 26, 77-81.

Marsh, H. W. (1990). Influences of internal and external frames of reference on the formation of math and English self-concepts. *Journal of Educational Psychology, 82*, 107-116.

Mervasch, Z. R. (1991). Learning mathematics in different mastery environments. *Journal of Educational Research, 84*, 225-231.

Miles, C. C. (1954). Gifted children. In L. Carmichael (Ed.), *Manual of child psychology* (pp. 984-1063). New York: John Wiley & Sons.

Milgram, R. M., & Milgram, N. A. (1976). Personality characteristics of gifted Israeli children. *The Journal of Genetic Psychology, 129*, 185-194.

Oakes, J. (1985). *Keeping track: How schools structure inequality*. New Haven, CT: Yale University Press.

Oickle, E. (1980). *A comparison of individual and team learning*. Unpublished doctoral dissertation, University of Maryland.

Olszewski, P., Kulieke, M. J., & Willis, G. B. (1987). Changes in the self-perception of gifted students who participate in rigorous academic programs. *Journal for the Education of the Gifted, 10*, 287-303.

Overall, J. E., & Woodward, J. A. (1975). Unreliability of difference scores: A paradox for measurement of change. *Psychological Bulletin, 82*, 85-86.

Petty, M. C. (1953). *Intraclass grouping in the elementary schools*. Austin, TX: The University of Texas Press.

Putbrese, L. M. (1971). An investigation into the effect of selected patterns of grouping upon arithmetic achievement. *Dissertation Abstracts International, 32*, 5113A. (University Microfilms No. 72-08388).

Robinson, A. (1990). Cooperation or exploitation? The argument against cooperative learning for talented students. *Journal for the Education of the Gifted, 14*, 9-27.

Robinson, A. (1991). *Cooperative learning and the academically talented student* (RBDM 9106). Storrs, CT: University of Connecticut, The National Research Center on the Gifted and Talented.

Rogers, K. B. (1991). *The relationship of grouping practices to the education of the gifted and talented learner* (RBDM 9102). Storrs, CT: University of Connecticut, The National Research Center on the Gifted and Talented.

Schatz, E. (1990, May/June). Ability grouping for gifted learners. *Educating Able Learners, 3-15*.

Schneider, B. H., Clegg, M. R., Byrne, B. M., Ledingham, J. E., & Crombie, G. (1989). Social relations of gifted children as a function of age and school program. *Journal of Educational Psychology, 81*, 48-56.

Sharan, S. (1980). Cooperative learning in small groups: Recent methods and effects on achievement, attitudes, and ethnic relations. *Review of Educational Research, 50*, 241-271.

Sharan, S., Ackerman, Z., & Hertz-Lazarowitz, R. (1980). Academic achievement of elementary school children in small-group versus whole-class instruction. *Journal of Experimental Education, 48*, 125-129.

Sharan, S., & Sharan, Y. (1976). *Small-group teaching*. Englewood Cliffs, NJ: Educational Technology Publications.

Shields, J. M. (1927). Teaching reading through ability-grouping. *Journal of Educational Methods, 7*, 7-9.

Sicola, P. K. (1990). Where do gifted students fit? An examination of middle school philosophy as it relates to ability grouping and the gifted learner. *Journal for the Education of the Gifted, 14*, 37-49.

Slavin, R. E. (1978). Student teams and comparison among equals: Effects on academic performance and student attitudes. *Journal of Educational Psychology, 70*, 532-538.

Slavin, R. E. (1986). *Using student team learning* (3rd ed.). Baltimore: Johns Hopkins University, Center for Research on Elementary and Middle Schools.

Slavin, R. E. (1987). Ability grouping and student achievement in elementary schools: A best evidence synthesis. *Review of Educational Research, 57*, 293-336.

Slavin, R. E. (1990a). Ability grouping, cooperative learning and the gifted. *Journal for the Education of the Gifted, 14*, 3-8.

Slavin, R. E. (1990b). *Cooperative learning: Theory, research, and practice*. Englewood Cliffs, NJ: Prentice-Hall.

Slavin, R. E. (1991a). Are cooperative learning and "untracking" harmful to the gifted: Response to Allan. *Educational Leadership, 48*(6), 68-71.

Slavin, R. E. (1991b). *Student team learning: A practical guide to cooperative learning* (3rd ed.). Washington, DC: National Education Association.

Slavin, R. E. (1991c). Synthesis of research on cooperative learning. *Educational Leadership, 48*(5), 71-82.

Slavin, R. E., & Karweit, N. (1981). Cognitive and affective outcomes of an intensive student team learning experience. *Journal of Experimental Education, 50*, 29-35.

Slavin, R. E., & Karweit, N. (1984, April). *Within-class ability grouping and student achievement*. Paper presented at the annual meeting of the American Educational Research Association, New Orleans.

Slavin, R. E., Leavy, M., & Madden, N. (1984). Combining cooperative learning and individualized instruction: Effects on student mathematics achievement, attitudes, and behaviors. *Elementary School Journal, 84*, 409-422.

Smith, K., Johnson, D. W., & Johnson, R. (1982). The effects of cooperative and individualistic instruction on the achievement of handicapped, regular, and gifted students. *Journal of Social Psychology, 116*, 277-283.

Smith, W. M. (1960). The effect of intraclass ability grouping on arithmetic achievement in grades two through five. *Dissertation Abstracts International, 21*, 563. (University Microfilms No. 60-02984)

Spence, E. S. (1959). Intraclass grouping of pupils for instruction in arithmetic in the intermediate grades of the elementary school. *Dissertation Abstracts International, 19*, 1682. (University Microfilms No. 58-5635)

Stevens, R. J., Madden, N. A., Slavin, R. E., & Farnish, A. M. (1987). Cooperative integrated reading and composition: Two field experiments. *Reading Research Quarterly, 22*, 433-454.

Stevens, R. J., Slavin, R. E., & Farnish, A. M. (1991). The effects of cooperative learning and direct instruction in reading comprehension strategies on main idea identification. *Journal of Educational Psychology, 83*, 8-16.

Vaughan, V. (1990). *Meta-analysis of pull-out programs in gifted education*. Paper presented at the annual convention of the National Association for Gifted Children. Little Rock, AR.

Vinacke, W. E. (1963). *Intragroup power relations, strategy, and decisions in inter-triad competition* (Tech. Rep. No. 4). University of Hawaii, Honolulu.

Wallen, N. E., & Vowles, R. O. (1960). The effect of intraclass grouping on arithmetic achievement in the sixth grade. *Journal of Educational Psychology, 51*, 159-163.

Webb, N. M. (1982). Group composition, group interaction, and achievement in cooperative small groups. *Journal of Educational Psychology, 74*, 475-484.

Webb, N. M. (1984). Stability of small group interaction and achievement over time. *Journal of Educational Psychology, 76*, 211-224.

**Appendix A**  
**Mathematics and Science Achievement Tests**



Name: \_\_\_\_\_ Group Color: \_\_\_\_\_

Use your ruler to find the perimeter in centimeters of the figures below.

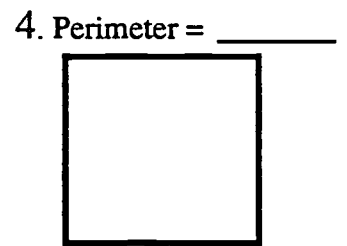
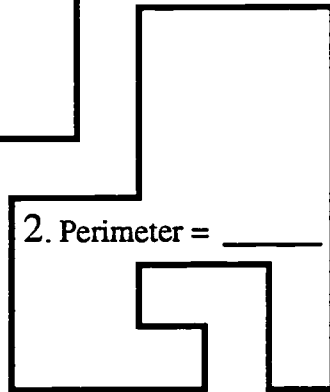
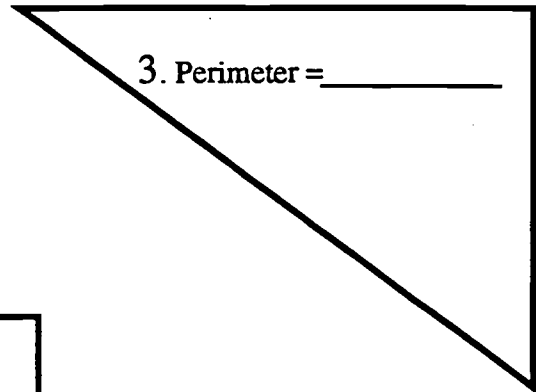
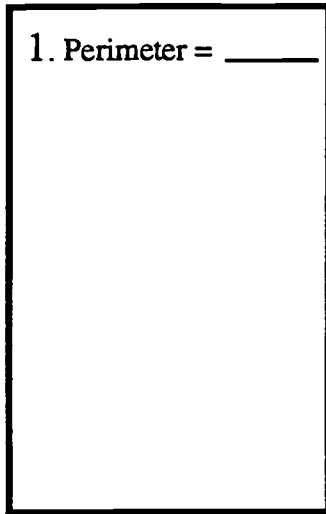

Find the area in square centimeters of the figures below.

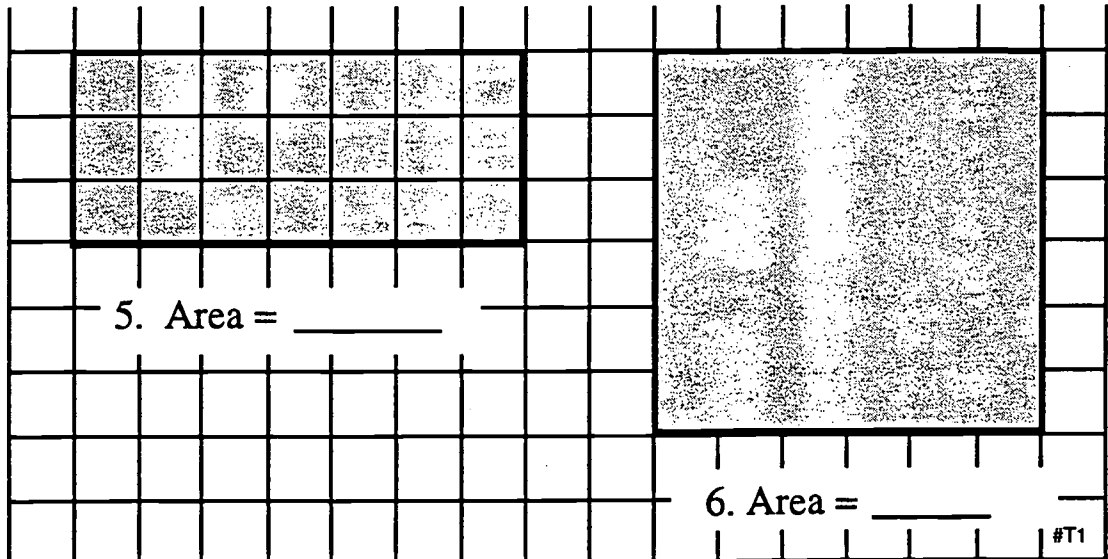

Use your ruler to find the area in square centimeters of the figure below.

7. Area = \_\_\_\_\_

8. The area and perimeter of a shape are always the same.  
TRUE FALSE (circle one)

9. What is one-half of 84? \_\_\_\_\_

Find the base and height in centimeters and the area in square centimeters of the three triangles below.

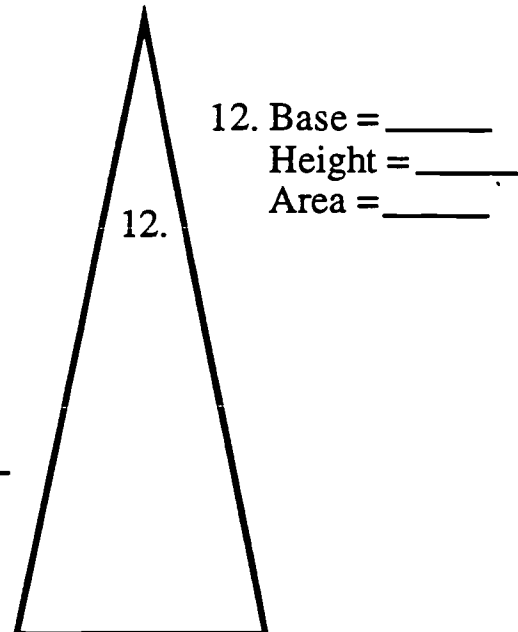
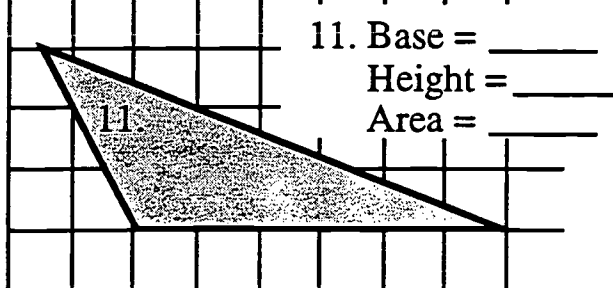
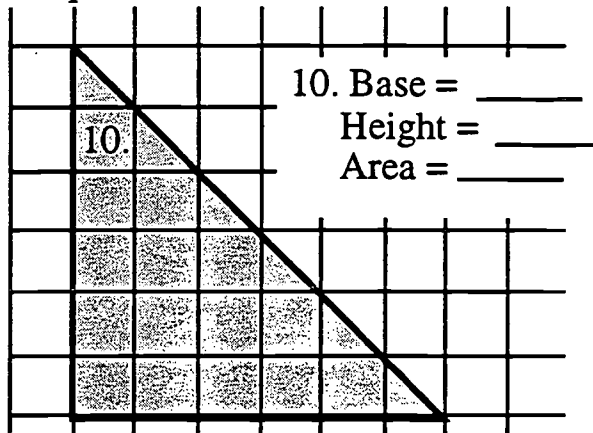

#T2

Use the kitchen plan below for a playhouse to answer the questions.

13. How many square centimeters does the stove cover? \_\_\_\_\_

14. How many square centimeters will all four items cover? \_\_\_\_\_

### Kitchen Plan

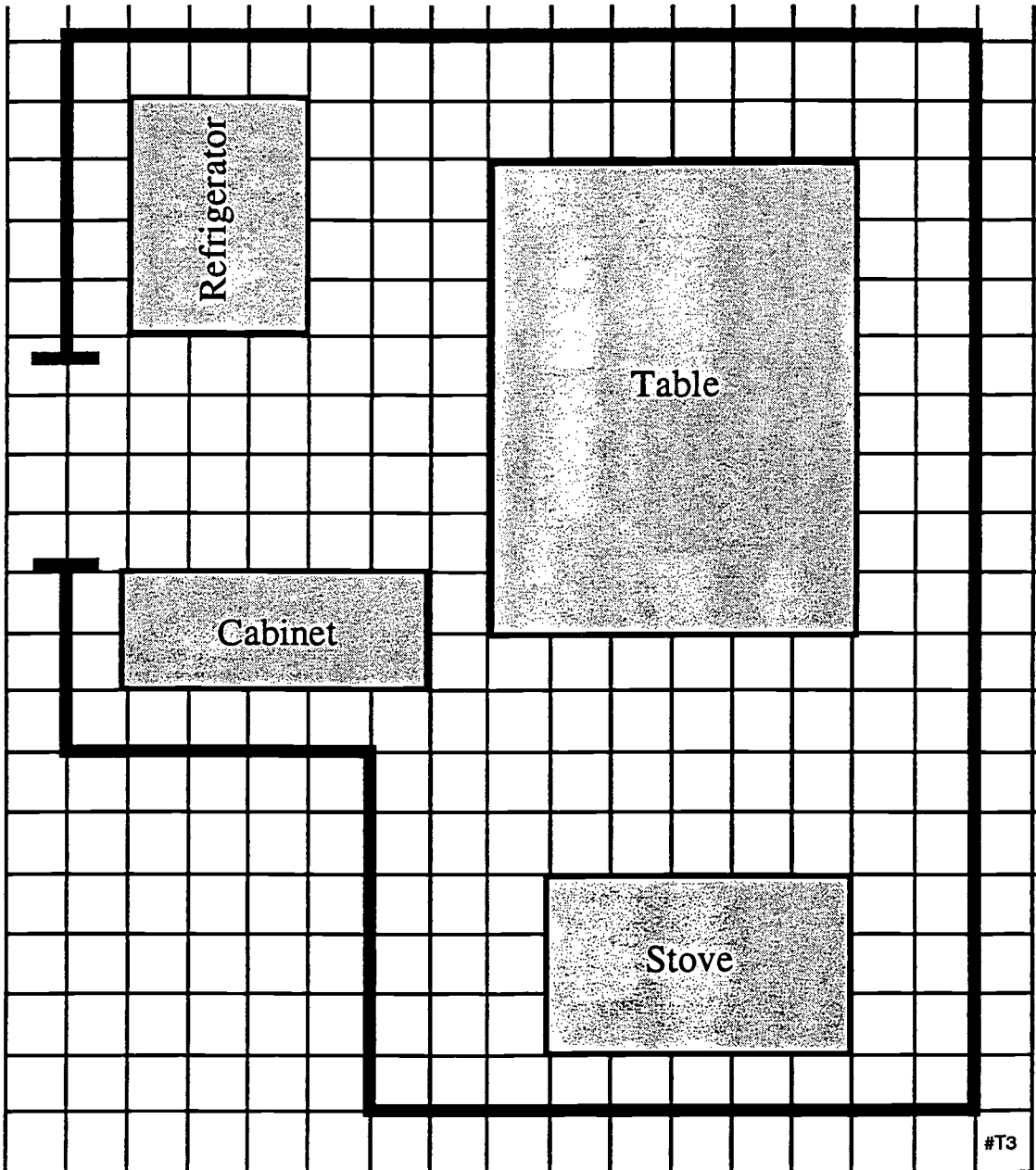

Estimate the area in square centimeters of the figure below.

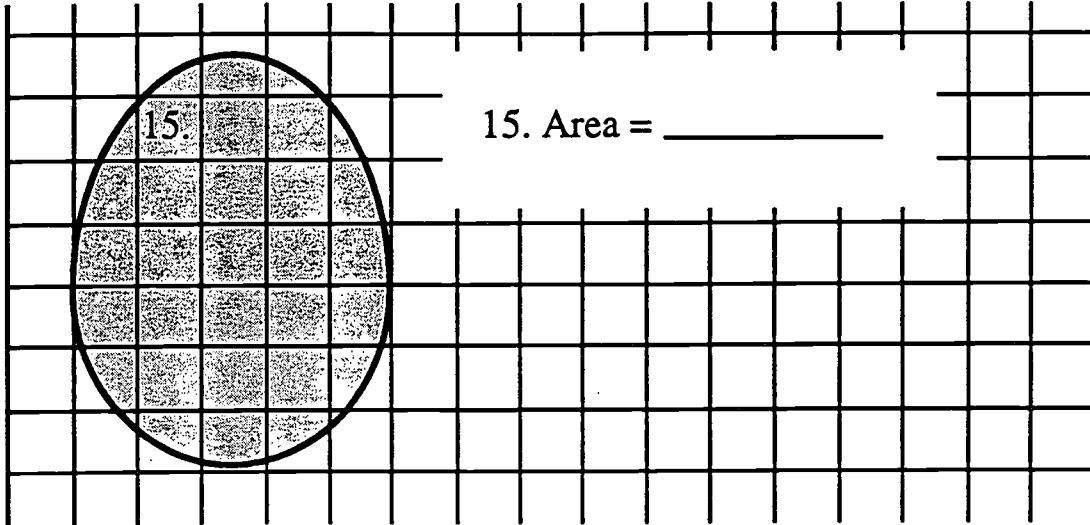

#T4

Science Quiz

Student Name \_\_\_\_\_

On the blank beside each **science word** write the letter of the correct **definition**.

Science Words

Definitions

- |       |                        |   |
|-------|------------------------|---|
| _____ | 1. static electricity  | a. source of energy we use everyday   |
| _____ | 2. circuit             | b. science term for negative charges  |
| _____ | 3. electricity         | c. the path that electrons flow in  |
| _____ | 4. current electricity | d. type of energy produced when there is a negative charges on an object              |
| _____ | 5. electron            | e. science term for positive charges  |
| _____ | 6. protons             | f. type of energy produced when negative charges flow through matter in one direction |

Use what you know about electricity to answer the following questions.

1. At a birthday party, Susan noticed balloons stuck to a wall without tape. Explain why this would happen. Use the following words to help you write the sentences.

**electron                  proton                  charges                  static electricity**

---



---



---



---

2. Draw a picture of a complete circuit and label the parts.

3. Name as many examples of static electricity as you can.

---

---

4. Explain the difference between current electricity and static electricity.

---

---

---

---

5. List three examples of conductors and three examples of insulators.

**Conductors**

**Insulators**

---

---

---

---

---

---

6. What is the one material an insulator can not be made from?

\_\_\_\_\_

7. Name two ways to make an electromagnet stronger.

\_\_\_\_\_  
\_\_\_\_\_

8. Explain why an electromagnet gets stronger using the words **Electron Flow**.

\_\_\_\_\_  
\_\_\_\_\_  
\_\_\_\_\_  
\_\_\_\_\_

9. Circle which picture shows the direction that electrons flow.

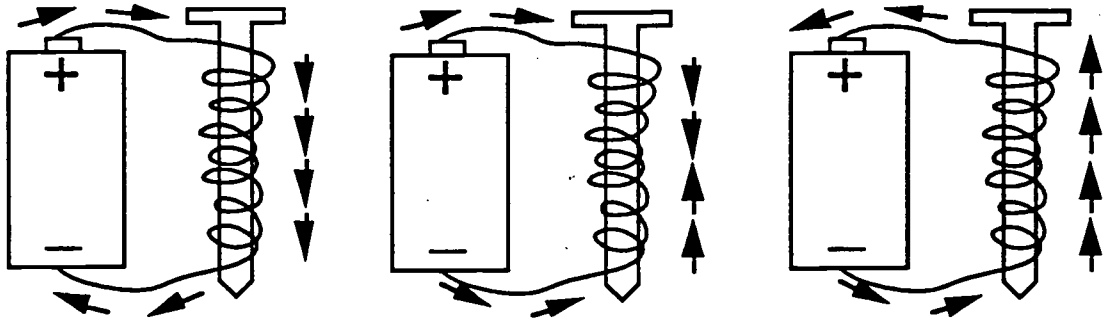

10. Draw a picture of a complete circuit which will light a bulb. Use **TWO** wires, a bulb, and a battery in your picture. LABEL all of the parts.
11. Draw a picture of a complete circuit which will light a bulb. Use wire, a bulb, and **TWO** batteries in your picture. LABEL all of the parts.



## Appendix B

### Modified Version of the *Self-Perception Profile for Children (SPPC)*

---

## What I Am Like

---

Name \_\_\_\_\_

### SAMPLE SENTENCE

	Really True for me	Sort of True for me		BUT		Sort of True for me	Really True for me
(a)	<input type="checkbox"/>	<input type="checkbox"/>	Some kids would rather play outdoors in their spare time.	BUT	Other kids would rather watch T.V.	<input type="checkbox"/>	<input type="checkbox"/>
<hr/>							
1.	<input type="checkbox"/>	<input type="checkbox"/>	Some kids feel that they are very <i>good</i> at their school work.	BUT	Other kids <i>worry</i> about whether they can do the school work assigned to them.	<input type="checkbox"/>	<input type="checkbox"/>
2.	<input type="checkbox"/>	<input type="checkbox"/>	Some kids find it <i>hard</i> to make friends.	BUT	Other kids find it's pretty <i>easy</i> to make friends.	<input type="checkbox"/>	<input type="checkbox"/>
3.	<input type="checkbox"/>	<input type="checkbox"/>	Some kids are often <i>unhappy</i> with themselves.	BUT	Other kids are pretty <i>pleased</i> with themselves.	<input type="checkbox"/>	<input type="checkbox"/>
4.	<input type="checkbox"/>	<input type="checkbox"/>	Some kids feel like they are <i>just as smart</i> as other kids their age.	BUT	Other kids aren't so sure and <i>wonder</i> if they are as smart.	<input type="checkbox"/>	<input type="checkbox"/>
5.	<input type="checkbox"/>	<input type="checkbox"/>	Some kids have <i>a lot of</i> friends.	BUT	Other kids <i>don't</i> have very many friends.	<input type="checkbox"/>	<input type="checkbox"/>
6.	<input type="checkbox"/>	<input type="checkbox"/>	Some kids <i>don't</i> like the way they are leading their life.	BUT	Other kids <i>do</i> like the way they are leading their life.	<input type="checkbox"/>	<input type="checkbox"/>
7.	<input type="checkbox"/>	<input type="checkbox"/>	Some kids are pretty <i>slow</i> in finishing their school work.	BUT	Other kids can do their school work <i>quickly</i> .	<input type="checkbox"/>	<input type="checkbox"/>
8.	<input type="checkbox"/>	<input type="checkbox"/>	Some kids would like to have a lot more friends.	BUT	Other kids have as many friends as they want.	<input type="checkbox"/>	<input type="checkbox"/>

- |     | Really<br>True<br>for me | Sort of<br>True<br>for me |   |     | Sort of<br>True<br>for me                                       | Really<br>True<br>for me |                          |
|-----|--------------------------|---------------------------|---|-----|---|--------------------------|--------------------------|
| 9.  | <input type="checkbox"/> | <input type="checkbox"/>  | Some kids are <i>happy</i> with themselves as a person.                   | BUT | Other kids are often <i>not</i> happy with themselves.          | <input type="checkbox"/> | <input type="checkbox"/> |
| 10. | <input type="checkbox"/> | <input type="checkbox"/>  | Some kids often <i>forget</i> what they learn.                            | BUT | Other kids can remember things <i>easily</i> .                  | <input type="checkbox"/> | <input type="checkbox"/> |
| 11. | <input type="checkbox"/> | <input type="checkbox"/>  | Some kids are always doing things with <i>a lot</i> of kids.              | BUT | Other kids usually do things by <i>themselves</i> .             | <input type="checkbox"/> | <input type="checkbox"/> |
| 12. | <input type="checkbox"/> | <input type="checkbox"/>  | Some kids like the kind of <i>person</i> they are.                        | BUT | Other kids often wish they were someone else.                   | <input type="checkbox"/> | <input type="checkbox"/> |
| 13. | <input type="checkbox"/> | <input type="checkbox"/>  | Some kids do <i>very well</i> at their classwork.                         | BUT | Other kids <i>don't</i> do very well at their classwork.        | <input type="checkbox"/> | <input type="checkbox"/> |
| 14. | <input type="checkbox"/> | <input type="checkbox"/>  | Some kids wish that more people their age liked them.                     | BUT | Other kids feel that most people their age <i>do</i> like them. | <input type="checkbox"/> | <input type="checkbox"/> |
| 15. | <input type="checkbox"/> | <input type="checkbox"/>  | Some kids are very <i>happy</i> being the way they are.                   | BUT | Other kids wish they were <i>different</i> .                    | <input type="checkbox"/> | <input type="checkbox"/> |
| 16. | <input type="checkbox"/> | <input type="checkbox"/>  | Some kids have <i>trouble</i> figuring out the answers in school.         | BUT | Other kids almost <i>always</i> can figure out the answers.     | <input type="checkbox"/> | <input type="checkbox"/> |
| 17. | <input type="checkbox"/> | <input type="checkbox"/>  | Some kids are <i>popular</i> with others their age.                       | BUT | Other kids are <i>not</i> very popular.                         | <input type="checkbox"/> | <input type="checkbox"/> |
| 18. | <input type="checkbox"/> | <input type="checkbox"/>  | Some kids <i>are</i> not very happy with the way they do a lot of things. | BUT | Other kids think the way they do things is <i>fine</i> .        | <input type="checkbox"/> | <input type="checkbox"/> |

Susan Harter, Ph.D., University of Denver, 1985

## Appendix C

### **Pretreatment and Posttreatment Versions of the *Student Attitudes Questionnaire (SAQ)***

**STUDENT ATTITUDES QUESTIONNAIRE (SAQ)**  
(Pretreatment)

NAME \_\_\_\_\_

Directions: Please answer the questions below by circling a number 1-4. There are no right answers. Nobody in your school will ever see what numbers you circle. Here is a sample of what to do:

SAMPLE: How nice is Mr. Rogers?

1	2	3	4
Not nice	A little nice	Very nice	Totally nice

1. How well do you know \_\_\_\_\_?

1	2	3	4
Don't know at all	Hardly know	Know a little	Totally know

2. How friendly is \_\_\_\_\_?

1	2	3	4
Not friendly at all	A little friendly	Very friendly	Totally friendly

3. Will \_\_\_\_\_ be a good teammate in a group?

1	2	3	4
Not a good teammate	Just an okay teammate	A good teammate	A great teammate

4. How smart is \_\_\_\_\_?

1	2	3	4
Not smart	A little smart	Very smart	Totally smart

5. How much do you like \_\_\_\_\_?

1	2	3	4
Don't like at all	Like a little	Really like	Totally like

6. What kind of leader is \_\_\_\_\_?

1	2	3	4
Not a leader at all	An okay leader	A good leader	A great leader

7. How much would you play with \_\_\_\_\_ after school?

1	2	3	4
Never play	Would play if I had do	Play a little	Always would play

8. How shy is \_\_\_\_\_?

1	2	3	4
Not shy at all	A little shy	Very shy	Totally shy



Thank you for your help in filling this out!



**STUDENT ATTITUDES QUESTIONNAIRE (SAQ)**  
(Posttreatment)

NAME \_\_\_\_\_

Directions: Please answer the questions below by circling a number 1-4. There are no right answers. Nobody in your school will ever see what numbers you circle. Here is a sample of what to do:

SAMPLE: How nice is your teacher?

1	2	3	4
Not nice	A little nice	Very nice	Totally nice

1. How friendly is \_\_\_\_\_?

1	2	3	4
Don't know at all	Hardly know	Know a little	Totally know

2. What kind of a leader is \_\_\_\_\_?

1	2	3	4
Not a leader at all	An okay leader	A good leader	A great leader

3. How shy is \_\_\_\_\_?

1	2	3	4
Not shy at all	A little shy	Very shy	Totally shy

4. How much would you play with \_\_\_\_\_ after school?

1	2	3	4
Never play	Would play if I had do	Play a little	Always would play

5. How much did \_\_\_\_\_ help you?

1	2	3	4
Do not help	Helped very little	Helped more than a little	Helped very much

6. How smart is \_\_\_\_\_?

1	2	3	4
Not smart	A little smart	Very smart	Totally smart

7. Would you want to be in another group with \_\_\_\_\_?

1	2	3	4
Would not want to	May want to, but I am not sure	Would sometimes like to	Would always want to

8. How much did you help \_\_\_\_\_?

1	2	3	4
Do not help	Helped very little	Helped more than a little	Helped very much

9. How much do you like \_\_\_\_\_?

1	2	3	4
Don't like at all	Like a little	Really like	Totally like

10. Was \_\_\_\_\_ a good teammate in a group?

1	2	3	4
Not a good teammate	Just an okay teammate	A good teammate	A great teammate



Thank you for your help in filling this out!





**Appendix D**  
***Content Area Preference Scale (CAPS)***































## CONTENT AREA PREFERENCE SCALE (CAPS)































My Name is \_\_\_\_\_ My teacher's name is \_\_\_\_\_

I am a BOY \_\_\_\_\_ GIRL \_\_\_\_\_

I am in Grade 2 \_\_\_\_\_ 3 \_\_\_\_\_ 4 \_\_\_\_\_ 5 \_\_\_\_\_ 6 \_\_\_\_\_

**Directions:** We would like to know how you feel about some of your school subjects. Please read each statement carefully and circle the face that shows how you feel about each statement. A happy face means that you agree with the statement. A face that is neither happy or sad means that you are not sure how you feel about the statement. A sad face means that you disagree with the statement.

- |   |   |   |   |
|---|---|---|---|
| 1. I learn a lot from reading.                    | <br>AGREE   |    | <br>DISAGREE   |
| 2. Mathematics is fun to do.                      | <br>AGREE   |    | <br>DISAGREE   |
| 3. Science is an interesting subject.             | <br>AGREE   |    | <br>DISAGREE   |
| 4. I think reading is fun.                        | <br>AGREE |  | <br>DISAGREE |
| 5. Learning about other countries is interesting. | <br>AGREE |  | <br>DISAGREE |
| 6. Mathematics is simple for me.                  | <br>AGREE |  | <br>DISAGREE |
| 7. Students need social studies classes.          | <br>AGREE |  | <br>DISAGREE |
| 8. I like to read stories.                        | <br>AGREE |  | <br>DISAGREE |
| 9. I want to take more science classes.           | <br>AGREE |  | <br>DISAGREE |
| 10. Social studies is important to me.            | <br>AGREE |  | <br>DISAGREE |

- |  |  |   |   |
|--|--|---|---|
| 11. Students should read often.                  | <br>AGREE   |    | <br>DISAGREE   |
| 12. Science is important to me.                  | <br>AGREE   |    | <br>DISAGREE   |
| 13. I want to know more about the United States. | <br>AGREE   |    | <br>DISAGREE   |
| 14. I read stories in my free time.              | <br>AGREE   |    | <br>DISAGREE   |
| 15. I think mathematics is interesting.          | <br>AGREE   |    | <br>DISAGREE   |
| 16. Students need science classes.               | <br>AGREE   |    | <br>DISAGREE   |
| 17. Schools should teach social studies.         | <br>AGREE  |   | <br>DISAGREE  |
| 18. Reading is important to me.                  | <br>AGREE |  | <br>DISAGREE |
| 19. Schools should teach mathematics.            | <br>AGREE |  | <br>DISAGREE |
| 20. Students should know how to read.            | <br>AGREE |  | <br>DISAGREE |

**Appendix E**  
**Mathematics Curriculum Worksheets**

# Line Measurement

Color Group \_\_\_\_\_

Use your ruler to measure the length of each of these lines.  
Place your answers in centimeters in the spaces provided.

- |         |         |
|---------|---------|
| A _____ | G _____ |
| B _____ | H _____ |
| C _____ | I _____ |
| D _____ | J _____ |
| E _____ |         |
| F _____ |         |

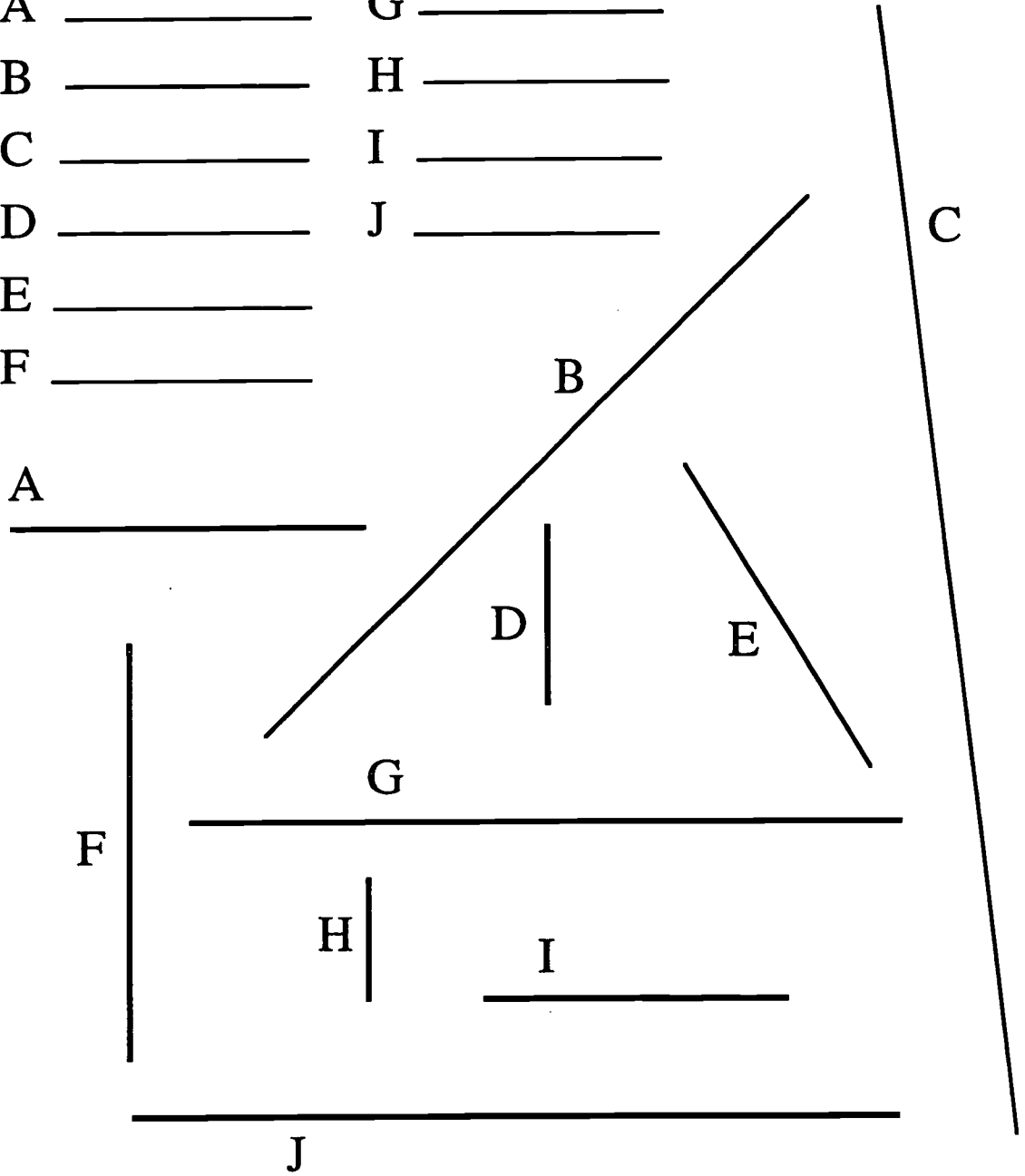

#1

## Introduction to Perimeter

Color Group \_\_\_\_\_

The distance around a figure is the **perimeter**. You find the **perimeter** of a figure by adding the lengths of the sides.

Use your ruler and measure the length in centimeters of each side of the rectangle shown below. Put your answers in the spaces at the bottom of the page. Add the lengths of the four sides to find the **perimeter**.

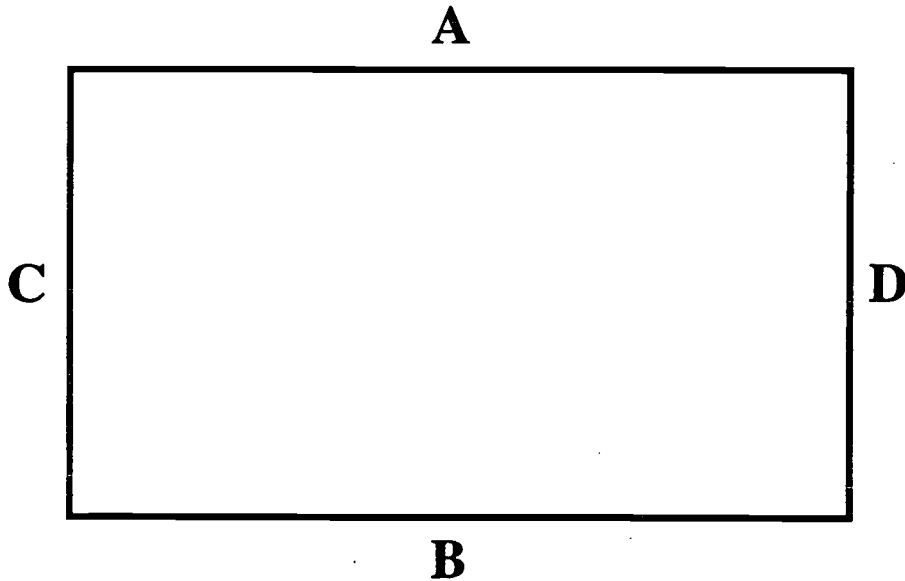

Add the lengths of each side of the rectangle to find the **perimeter** of the rectangle.

$$\frac{\quad}{\text{Side A}} + \frac{\quad}{\text{Side B}} + \frac{\quad}{\text{Side C}} + \frac{\quad}{\text{Side D}} = \frac{\quad}{\text{Perimeter}}$$

#2A

## Calculating Perimeter

Color Group \_\_\_\_\_

Use your ruler and measure the length in centimeters of each side of shapes shown below. Put your answers in the spaces beside each shape. Add the lengths of the four sides to find the **perimeter**.

A

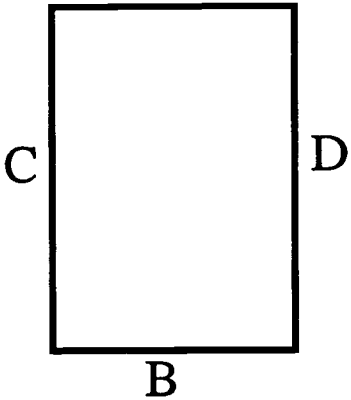

$$\frac{\quad}{A} + \frac{\quad}{B} + \frac{\quad}{C} + \frac{\quad}{D} = \frac{\quad}{\text{Perimeter}}$$

A

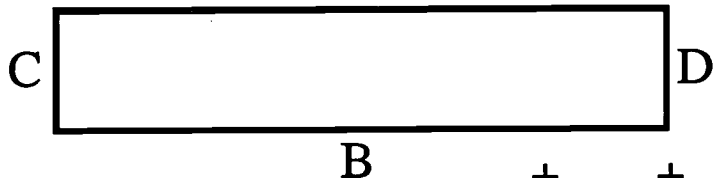

$$\frac{\quad}{A} + \frac{\quad}{B} + \frac{\quad}{C} + \frac{\quad}{D} = \frac{\quad}{\text{Perimeter}}$$

A

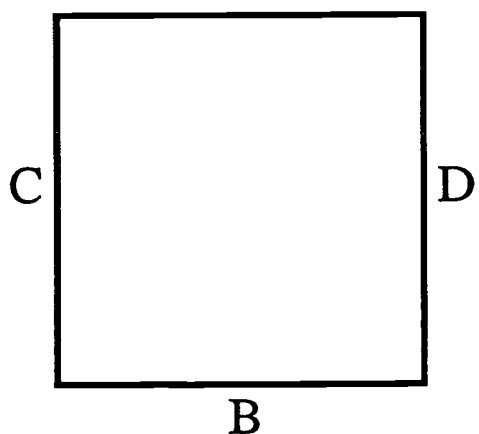

$$\frac{\quad}{A} + \frac{\quad}{B} + \frac{\quad}{C} + \frac{\quad}{D} = \frac{\quad}{\text{Perimeter}}$$

#2B

## Perimeter of Rectangles

Color Group \_\_\_\_\_

Use your ruler to measure the **perimeter** of the rectangles and squares below. Place your answers in centimeters in the spaces provided.

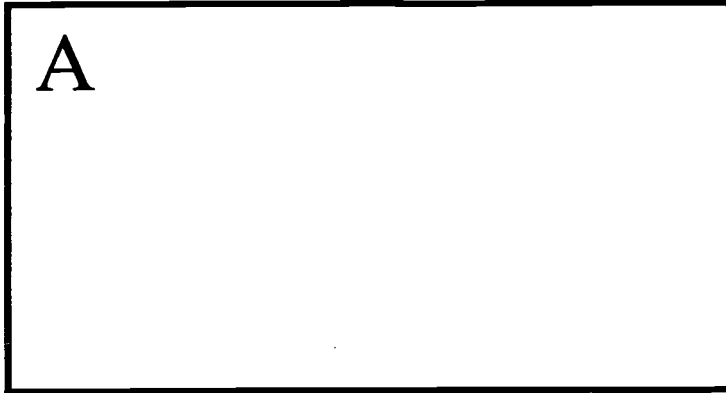

A \_\_\_\_\_

B \_\_\_\_\_

C \_\_\_\_\_

D \_\_\_\_\_

E \_\_\_\_\_

F \_\_\_\_\_

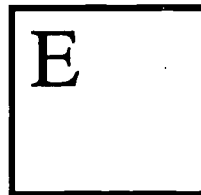
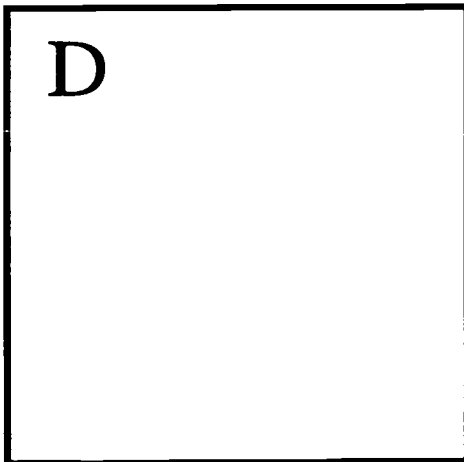
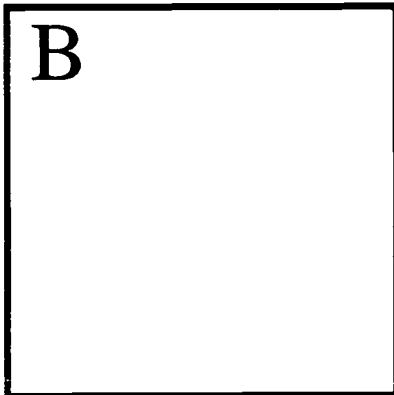

#3



## More Practice with Perimeter of Rectangles

Color Group \_\_\_\_\_

Use your ruler to measure the **perimeter** of the rectangles and squares below. Place your answers in centimeters in the spaces provided.

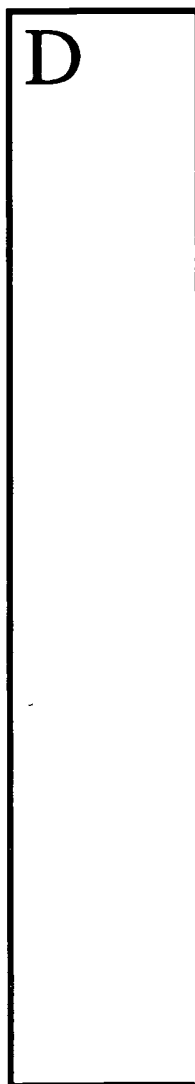
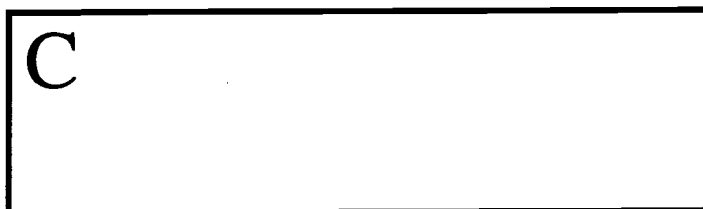
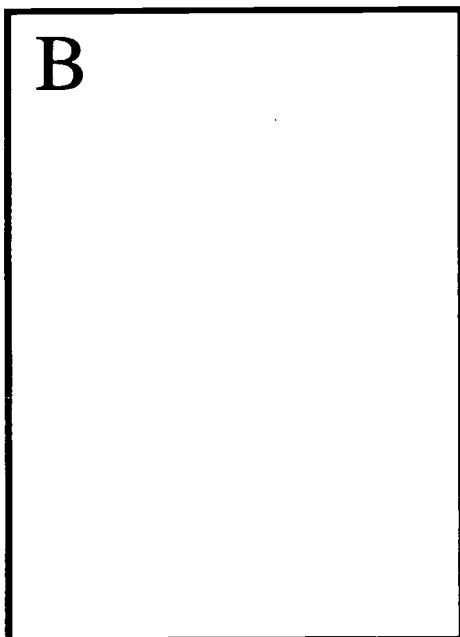
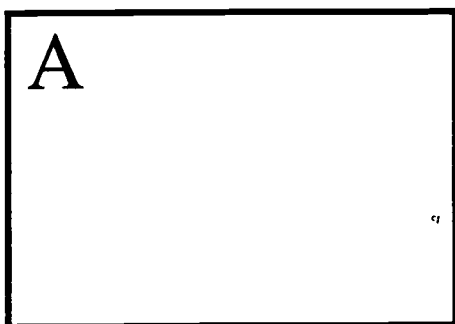

A \_\_\_\_\_

B \_\_\_\_\_

C \_\_\_\_\_

D \_\_\_\_\_

E \_\_\_\_\_

F \_\_\_\_\_

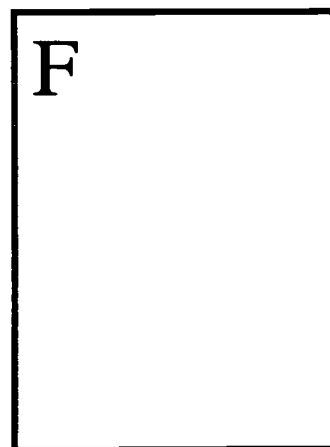

#4

# Perimeters of Polygons

Color Group \_\_\_\_\_

As you learned in a previous activity, the distance around a figure is the **perimeter**. We add the length of all the sides to find the **perimeter**. Measure each figure below and find the **perimeter**. Place your answers in centimeters in the spaces provided.

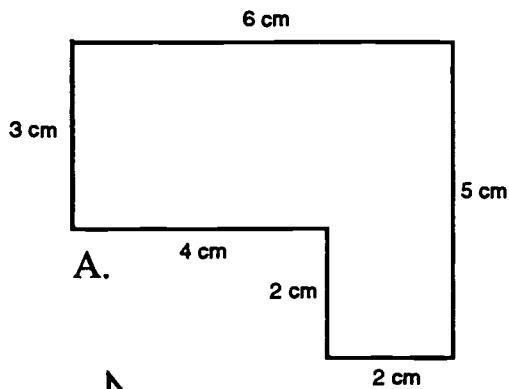

A.  $6 + 5 + 2 + 2 + 4 + 3 =$  \_\_\_\_\_

B. \_\_\_\_\_

C. \_\_\_\_\_

D. \_\_\_\_\_

E. \_\_\_\_\_

F. \_\_\_\_\_

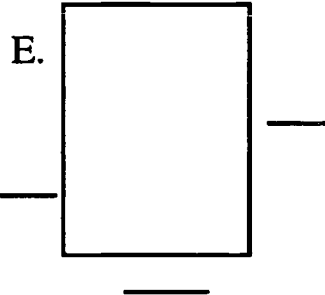
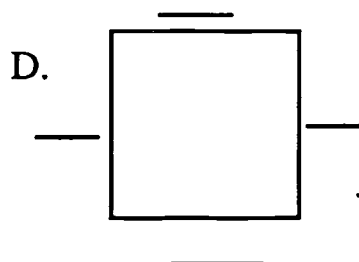
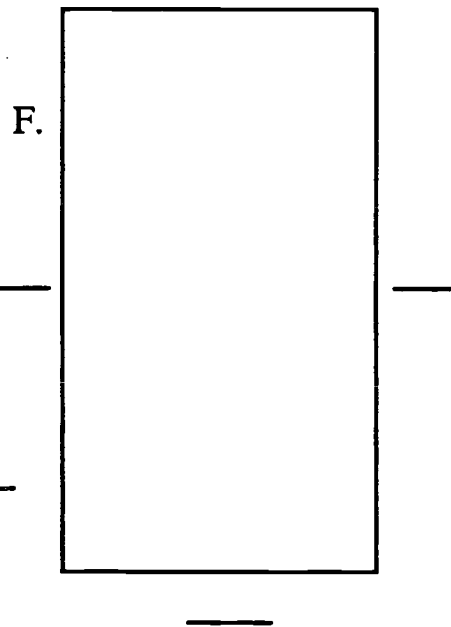
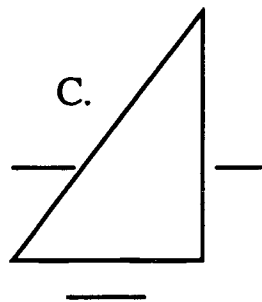
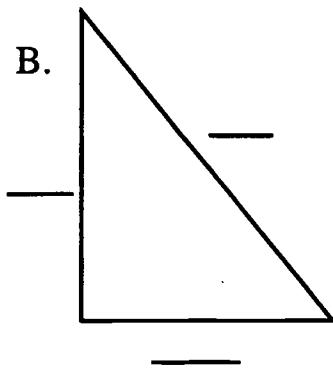

#5

# Practicing Perimeters

Color Group \_\_\_\_\_

As you learned in a previous activity, the distance around a figure is the **perimeter**. We add the length of all the sides to find the **perimeter**. Measure each figure below and put your measurements on the lines by each figure. Add the lengths of each side and place your answers in centimeters in the spaces provided.

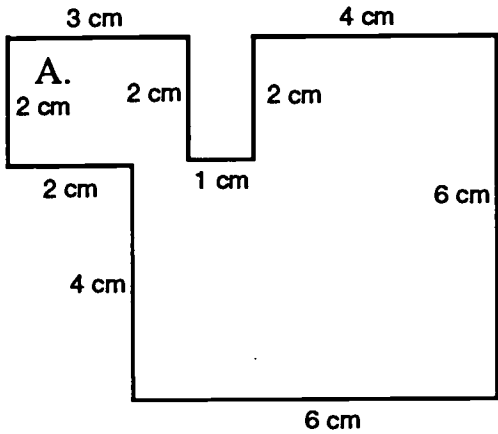

- A.  $3+2+1+2+4+6+6+4+2+2=$  \_\_\_\_\_
- B. \_\_\_\_\_
- C. \_\_\_\_\_
- D. \_\_\_\_\_
- E. \_\_\_\_\_

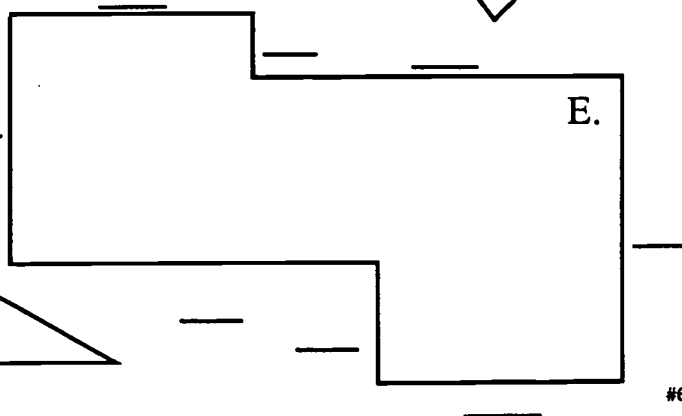
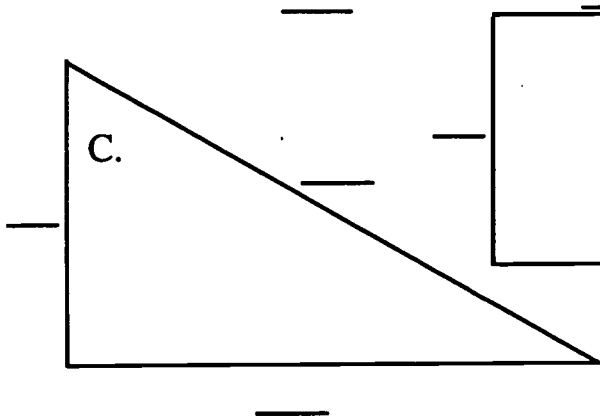
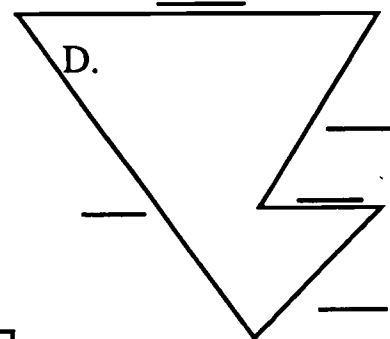
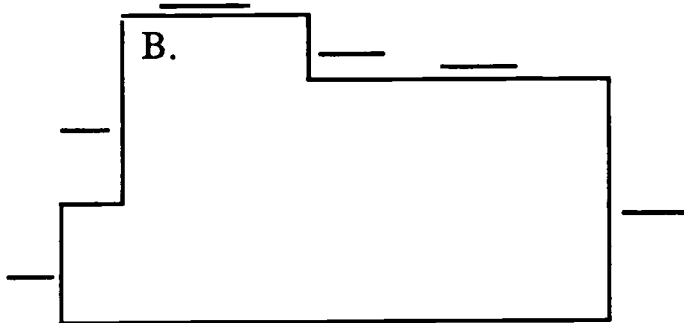

#6

# Multiple Sided Perimeters

Color Group \_\_\_\_\_

We add the length of all the sides of a figure to find the **perimeter**. Measure each figure below and put your measurements on the lines by each figure. Add the lengths of each side and place your answers in centimeters in the spaces provided.

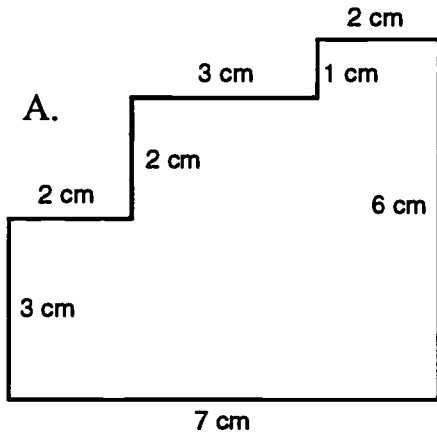

A.  $2+2+3+1+2+6+7+3 =$  \_\_\_\_\_

B. \_\_\_\_\_

C. \_\_\_\_\_

D. \_\_\_\_\_

E. \_\_\_\_\_

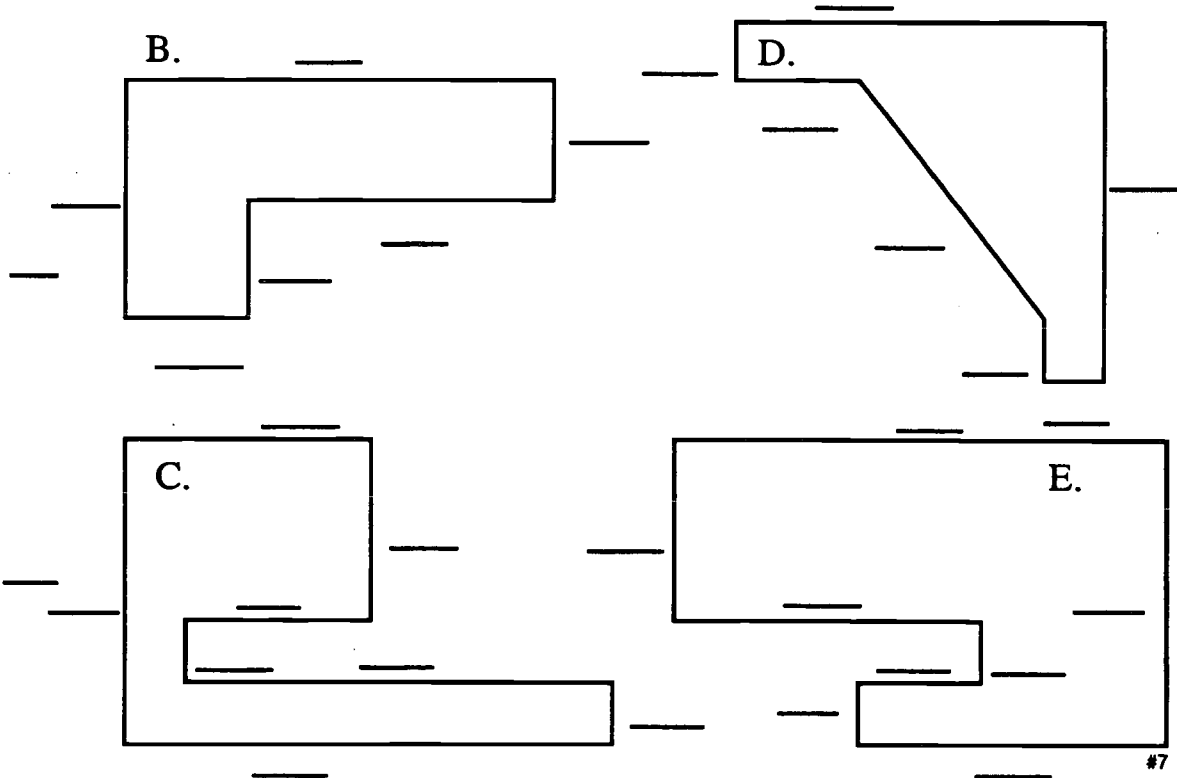

#7





# Calculating Area

Color Group \_\_\_\_\_

Counting the square units is not the easiest way to find the **area** of a figure. You can find the **area** of a rectangular region by multiplying the **length** by the **width**. Multiply the **length** by the **width** to find the areas of the rectangles below.

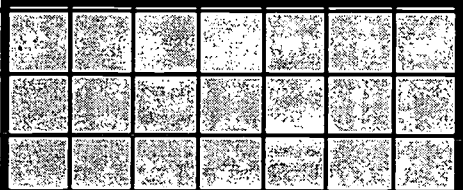
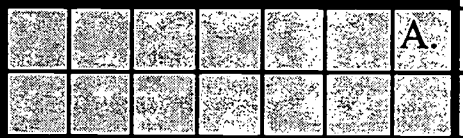
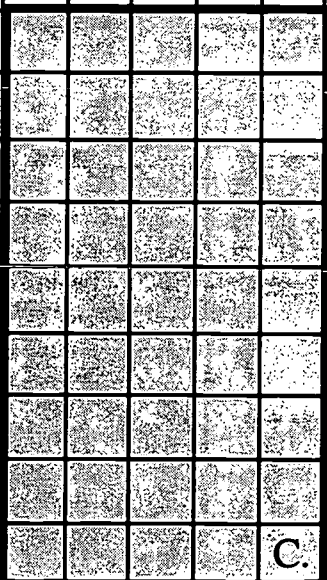
**Area = Length X Width**

Length = 7	
	$\frac{7}{\text{Length}} \times \frac{3}{\text{Width}} = \frac{21}{\text{Area}}$
	<p>A. <math>\frac{\quad}{\text{Length}} \times \frac{\quad}{\text{Width}} = \frac{\quad}{\text{Area}}</math></p>
	<p>C. <math>\frac{\quad}{\text{Length}} \times \frac{\quad}{\text{Width}} = \frac{\quad}{\text{Area}}</math></p>
	<p>B. <math>\frac{\quad}{\text{Length}} \times \frac{\quad}{\text{Width}} = \frac{\quad}{\text{Area}}</math></p>

#9

## Area Calculations

Color Group \_\_\_\_\_

Find the **area** of the rectangular regions below by multiplying the **length** by the **width**. Write your answers in square centimeters.

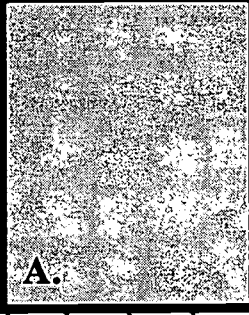
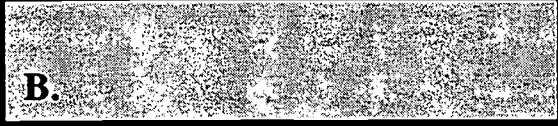
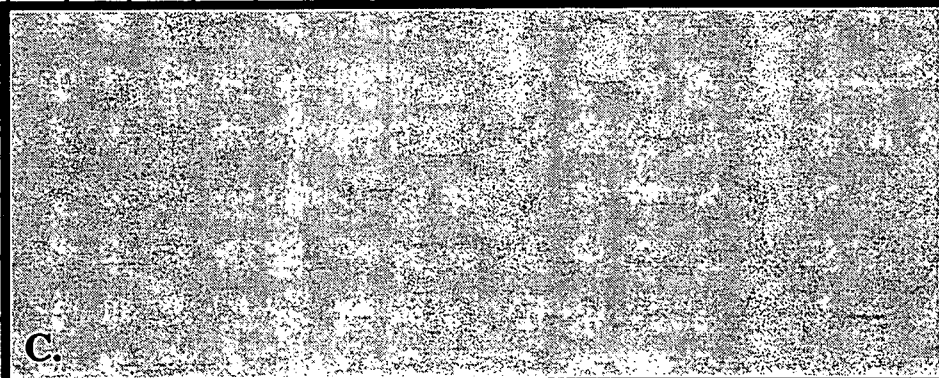
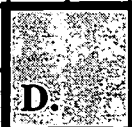
 <p><b>A.</b></p>	 <p><b>B.</b></p> $\frac{\quad}{\text{Length}} \times \frac{\quad}{\text{Width}} = \frac{\quad}{\text{Area}}$
$\frac{\quad}{\text{Length}} \times \frac{\quad}{\text{Width}} = \frac{\quad}{\text{Area}}$	
 <p><b>C.</b></p>	$\frac{\quad}{\text{Length}} \times \frac{\quad}{\text{Width}} = \frac{\quad}{\text{Area}}$
 <p><b>D.</b></p>	$\frac{\quad}{\text{Length}} \times \frac{\quad}{\text{Width}} = \frac{\quad}{\text{Area}}$

#10

## More Fun with Area Calculations

Color Group \_\_\_\_\_

Find the **area** of the rectangular regions below by multiplying the **length** by the **width**. Write your answer in square centimeters.

A. \_\_\_\_\_

B. \_\_\_\_\_

C. \_\_\_\_\_

D. \_\_\_\_\_

E. \_\_\_\_\_

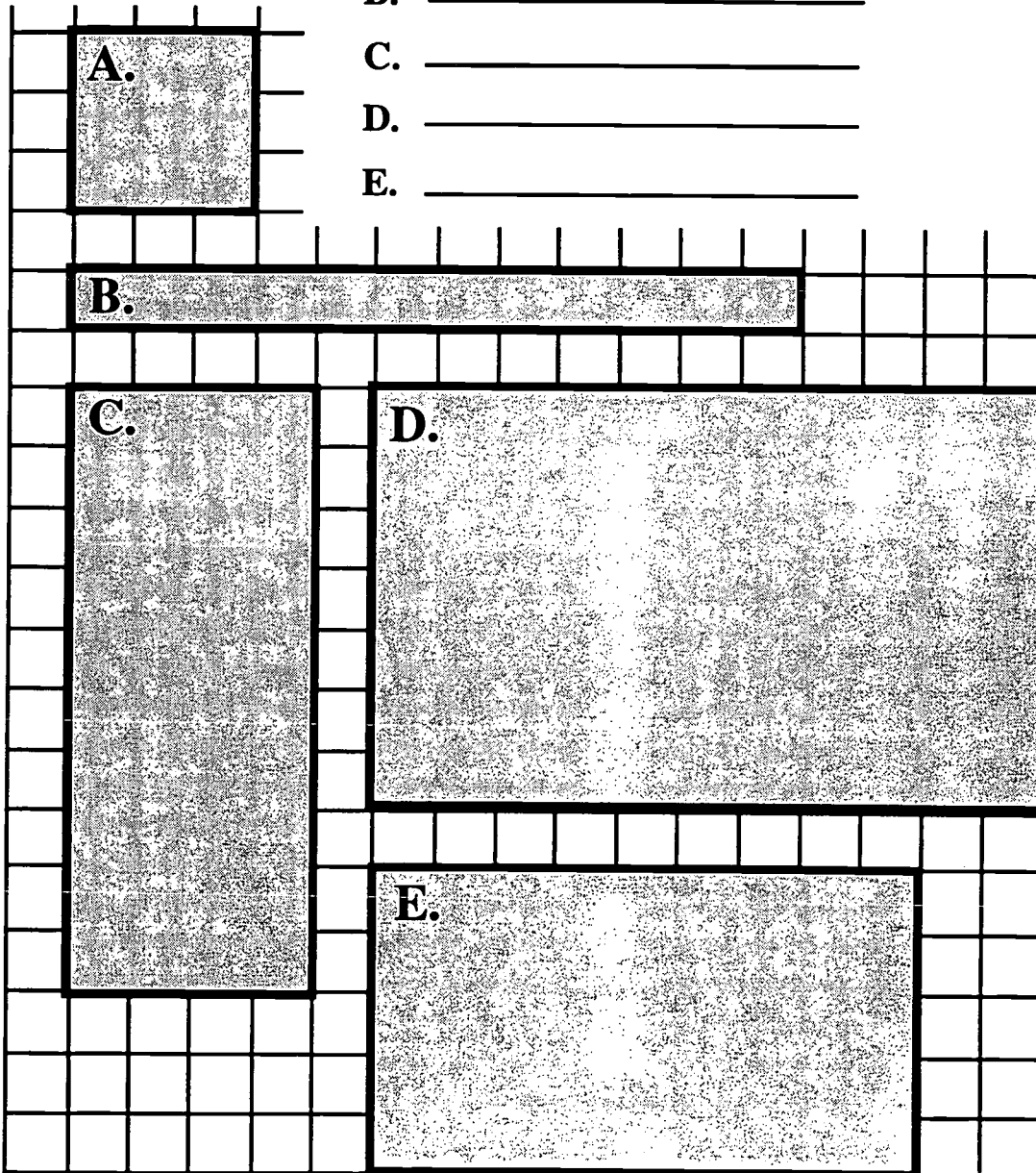

#11



## Measuring and Calculating Area

Color Group \_\_\_\_\_

Use your ruler to measure the **length** and **width** of the rectangles below. Find the **area** of each rectangle by multiplying the **length** by the **width**. Take your measurements in centimeters and write your answer in square centimeters. Write your answers on the lines at the bottom of the page.

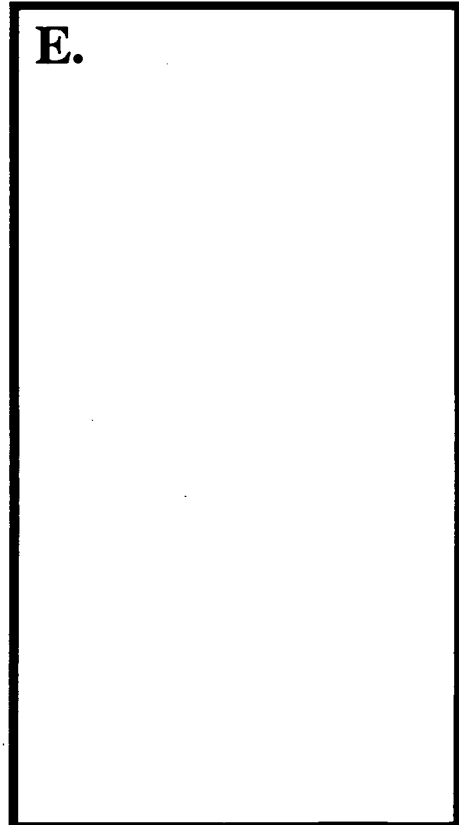
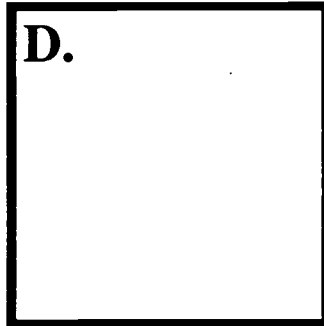
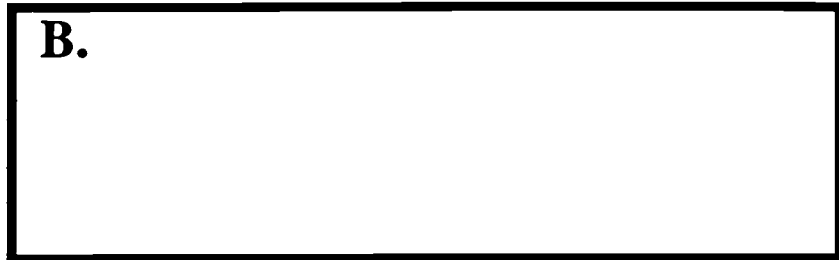
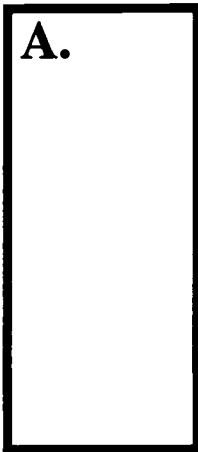

**A.** \_\_\_\_\_

**B.** \_\_\_\_\_

**C.** \_\_\_\_\_

**D.** \_\_\_\_\_

**E.** \_\_\_\_\_

#12

## Introduction to Squares

Color Group \_\_\_\_\_

Squares are special types of rectangles. Since all four sides of a square are the same length, you can find the **perimeter** of a square by multiplying the **length** of one side by 4.

The area of a square is calculated the same way the area of a rectangle is calculated. Since the **length** and **width** of a square are the same, you can calculate the area by measuring any side and multiplying that number by itself. We call this squaring the number.

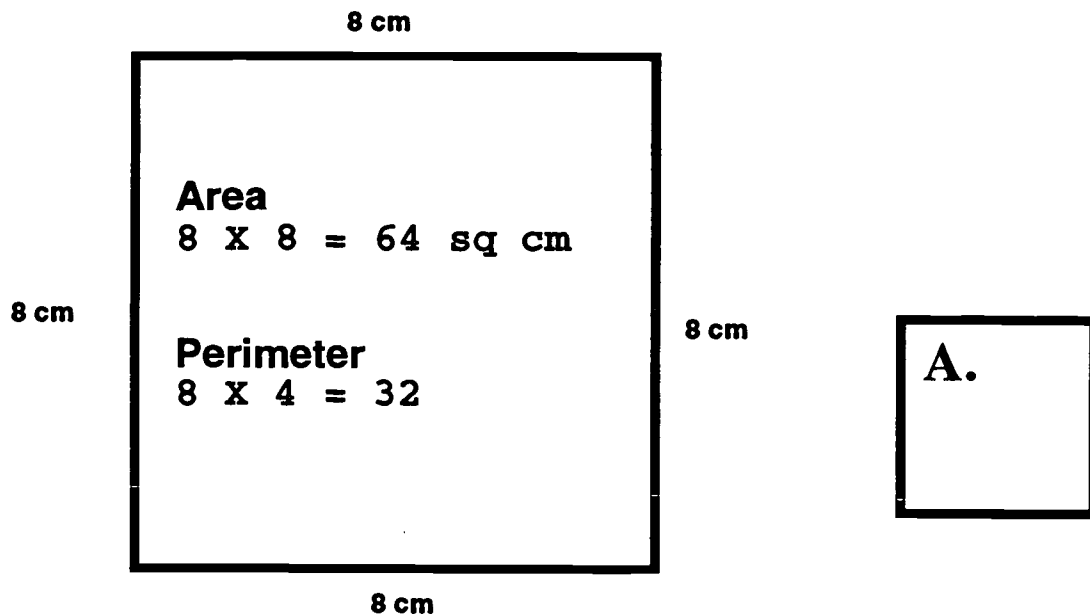

A. area      x      =           perimeter      x      =     

B. area      x      =           perimeter      x      =     

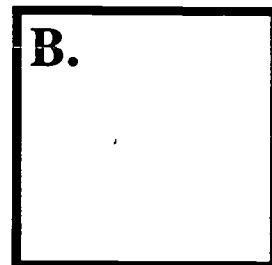

#13A

# Square Area and Perimeter

Color Group \_\_\_\_\_

Use your ruler to measure the **length** and **width** of the squares below. Find the **area** and **perimeter** of each square. Take your measurements in centimeters and write your answers in square centimeters and centimeters. Write your answers on the lines at the bottom of the page.

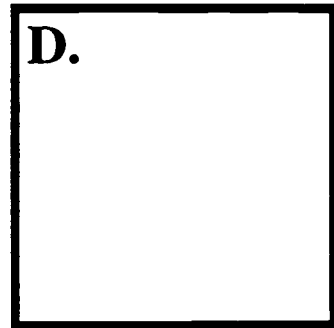
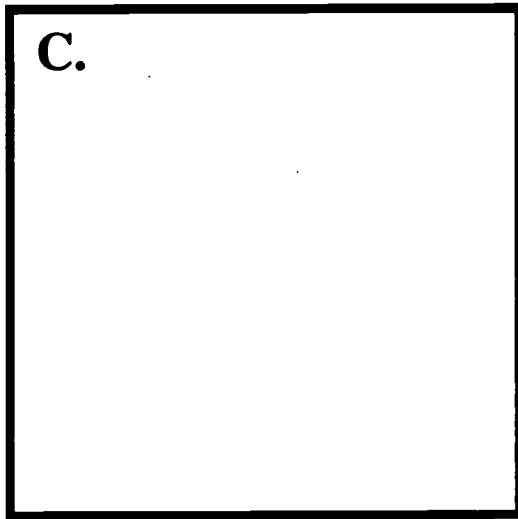
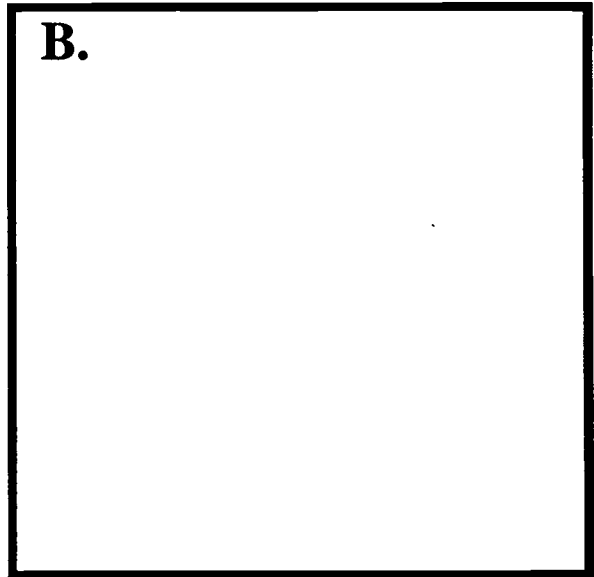
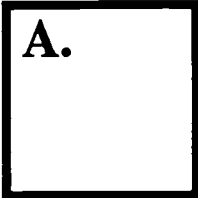

A. area= \_\_\_\_\_ perimeter = \_\_\_\_\_

B. area= \_\_\_\_\_ perimeter = \_\_\_\_\_

C. area= \_\_\_\_\_ perimeter = \_\_\_\_\_

D. area= \_\_\_\_\_ perimeter = \_\_\_\_\_

#13B

## Desk Plan

This plan shows what a desk could look like from above. Each square in the desk plan is equal to one square centimeter. Using the items on the desk, answer the questions on the next page.

**PIECE OF PAPER** - 5 cm x 7 cm

**TELEPHONE** - 4 cm x 3 cm

**BOOK** - 3 cm x 5 cm

**ERASER** - 4 cm x 2 cm

**PENCIL** - 5 cm x 1 cm

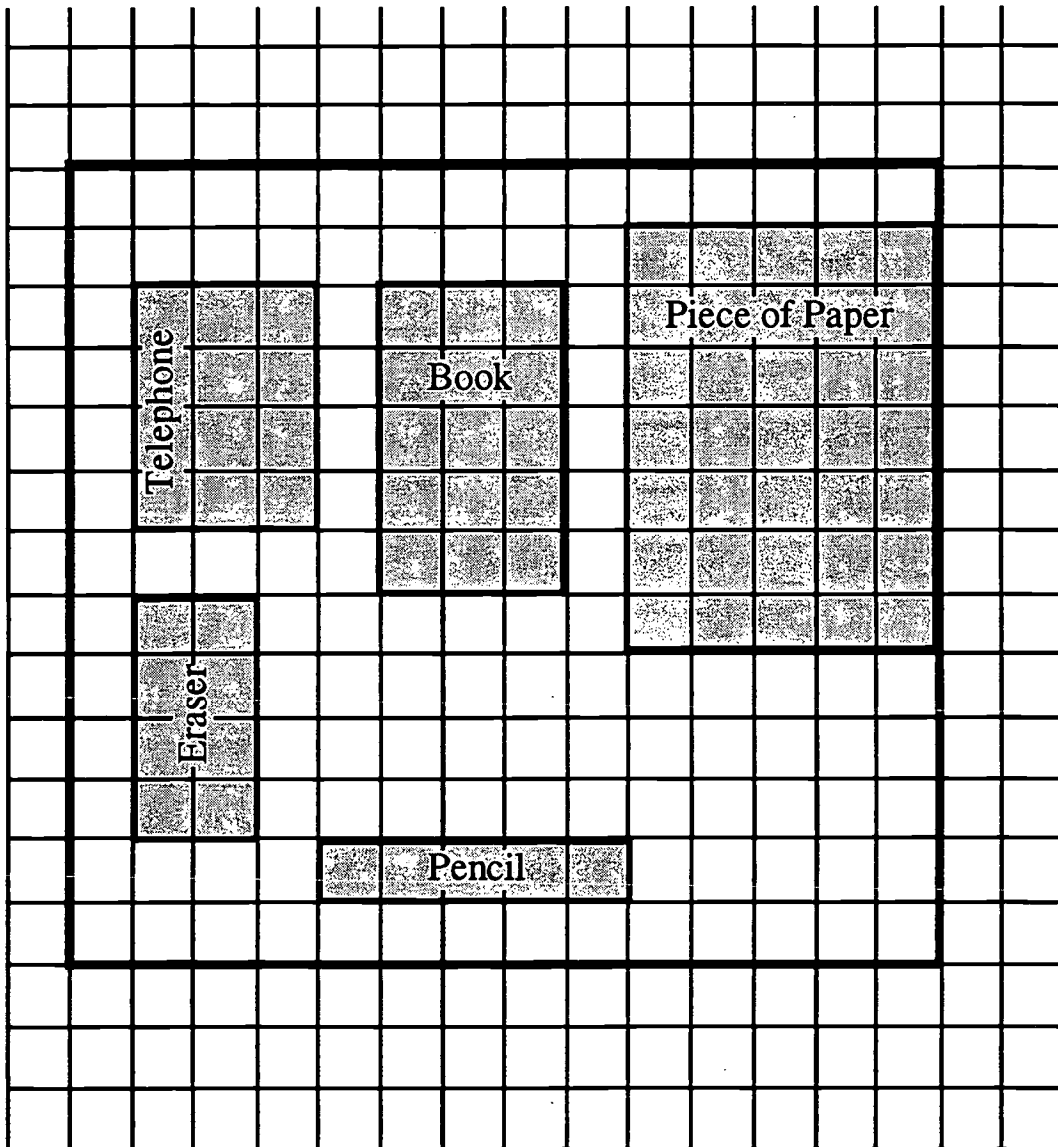

#14A

# Desk Plan Answer Sheet

Color Group \_\_\_\_\_

1. What is the length of the desk?

\_\_\_\_\_

2. What is the width of the desk?

\_\_\_\_\_

3. How many square centimeters is the desk?

\_\_\_\_\_

4. How many square feet does each item below cover?

PAPER\_\_\_\_\_ TELEPHONE\_\_\_\_\_ BOOK\_\_\_\_\_

ERASER\_\_\_\_\_ PENCIL \_\_\_\_\_

5. How many square centimeters will all five items cover?

\_\_\_\_\_

6. How many square centimeters will be left on the desk after each item is placed?

\_\_\_\_\_

# Area and Perimeter

Color Group \_\_\_\_\_

Find the area and perimeter of each of the rectangles and figures below. Answer the questions at the bottom of the page when you are finished.

1. Area = \_\_\_\_\_  
Perimeter = \_\_\_\_\_

2. Area = \_\_\_\_\_  
Perimeter = \_\_\_\_\_

3. Area = \_\_\_\_\_  
Perimeter = \_\_\_\_\_

4. Area = \_\_\_\_\_  
Perimeter = \_\_\_\_\_

5. Area = \_\_\_\_\_  
Perimeter = \_\_\_\_\_

6. Area = \_\_\_\_\_  
Perimeter = \_\_\_\_\_

	1		11																	
24	1	2	10	11	12															
23	2	3	9	10	13															
22	3	4	8	9	14															
21	4	5	7	8	15															
20	5	6	7	16																
	19	18	17																	

Area = 11  
Perimeter = 24

Area = \_\_\_\_\_  
Perimeter = \_\_\_\_\_

Area = \_\_\_\_\_  
Perimeter = \_\_\_\_\_

- Are the area and the perimeter of a shape always the same? \_\_\_\_\_
- Do rectangles which have the same area always have the same perimeter? \_\_\_\_\_

# Triangle Height and Base

Color Group \_\_\_\_\_

The width of a triangle is called the **base**. The **height** of a triangle is the distance straight up from the baseline to the top of the triangle.

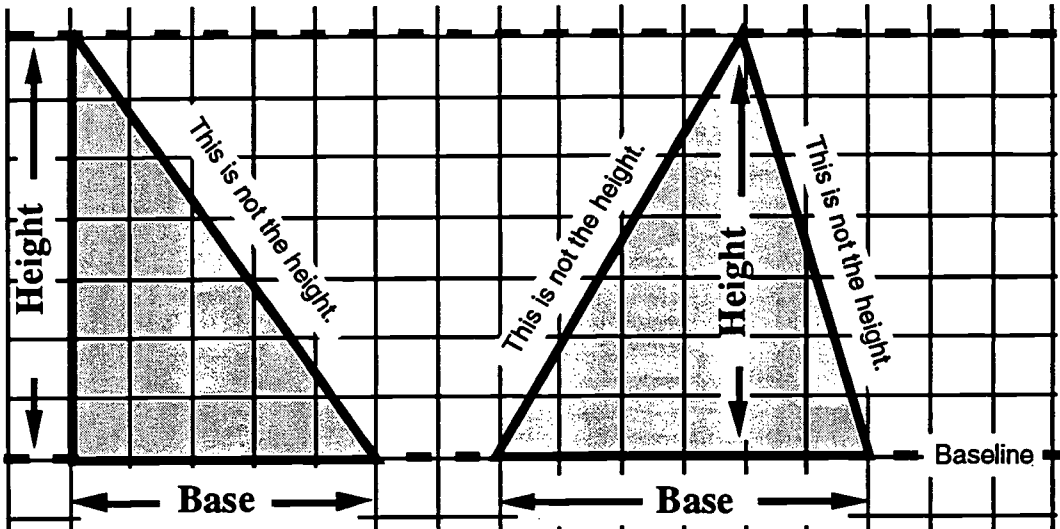

The **base** of the above triangle is 5 cm.

The **height** of the above triangle is 7 cm.

The **base** of the above triangle is 6 cm.

The **height** of the above triangle is 7 cm.

The **base** of the this triangle is 3 cm.

The **height** of the this triangle is 6 cm.

Do the problems on the next page

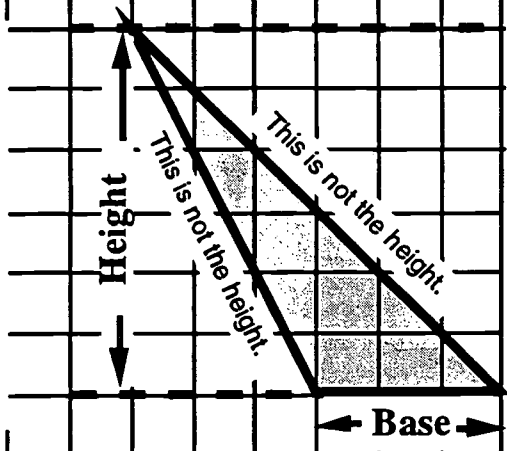

#16A

# Finding Height and Base

Color Group \_\_\_\_\_

Find the **base** and **height** of each of the triangles below. The first triangle has been completed for you.

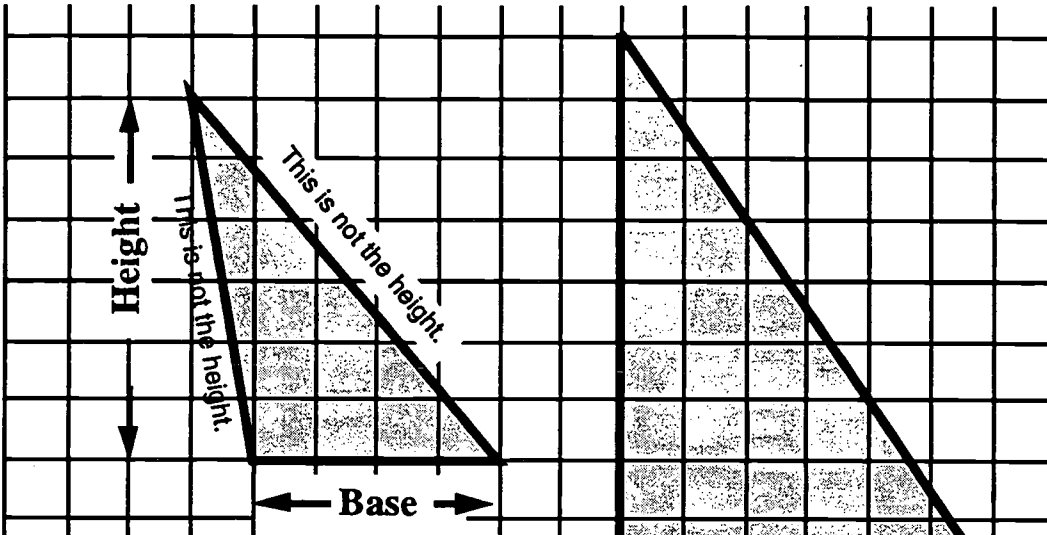

The **base** of the above triangle is 4 cm.

The **height** of the above triangle is 6 cm.

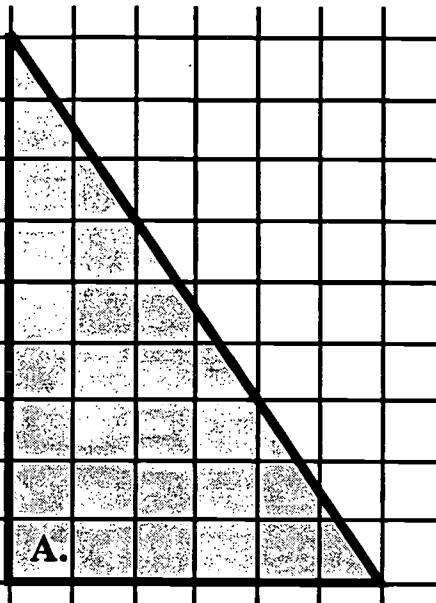

A. Base \_\_\_\_\_

Height \_\_\_\_\_

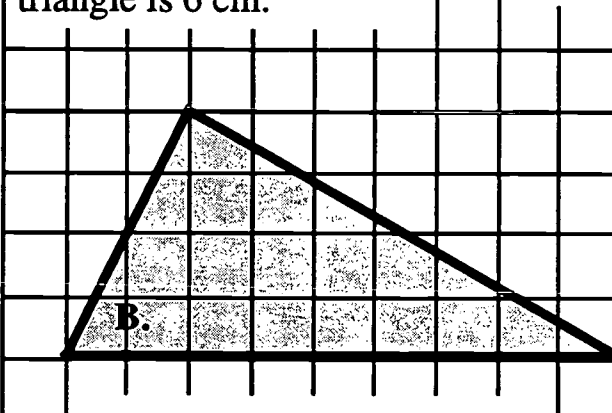

B. Base \_\_\_\_\_

Height \_\_\_\_\_

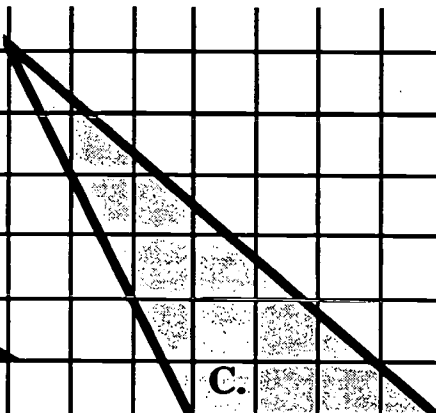

C. Base \_\_\_\_\_

Height \_\_\_\_\_

#16B



# Practice Finding Height and Base

Color Group \_\_\_\_\_

Find the base and height of each of the triangles below.

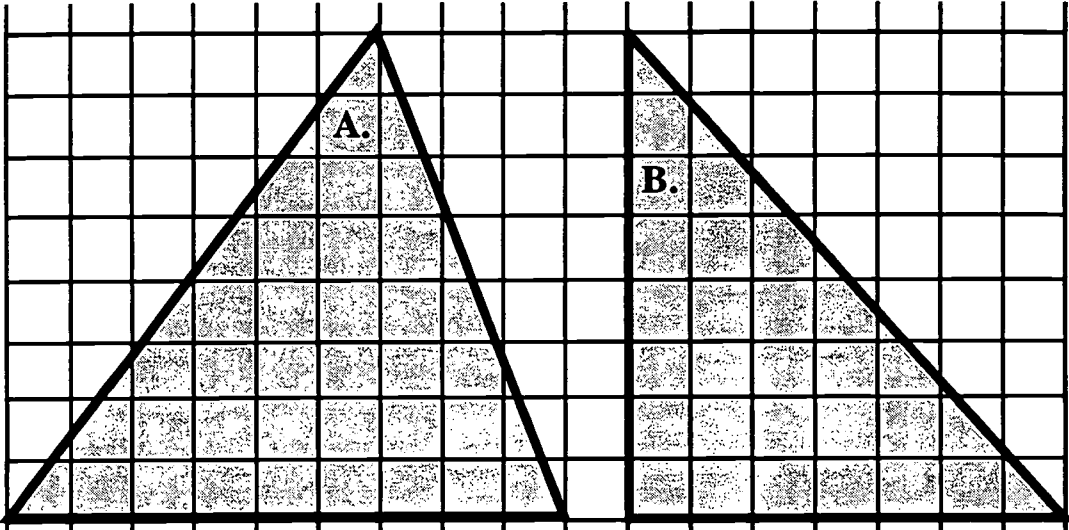

A. Base \_\_\_\_\_

B. Base \_\_\_\_\_

Height \_\_\_\_\_

Height \_\_\_\_\_

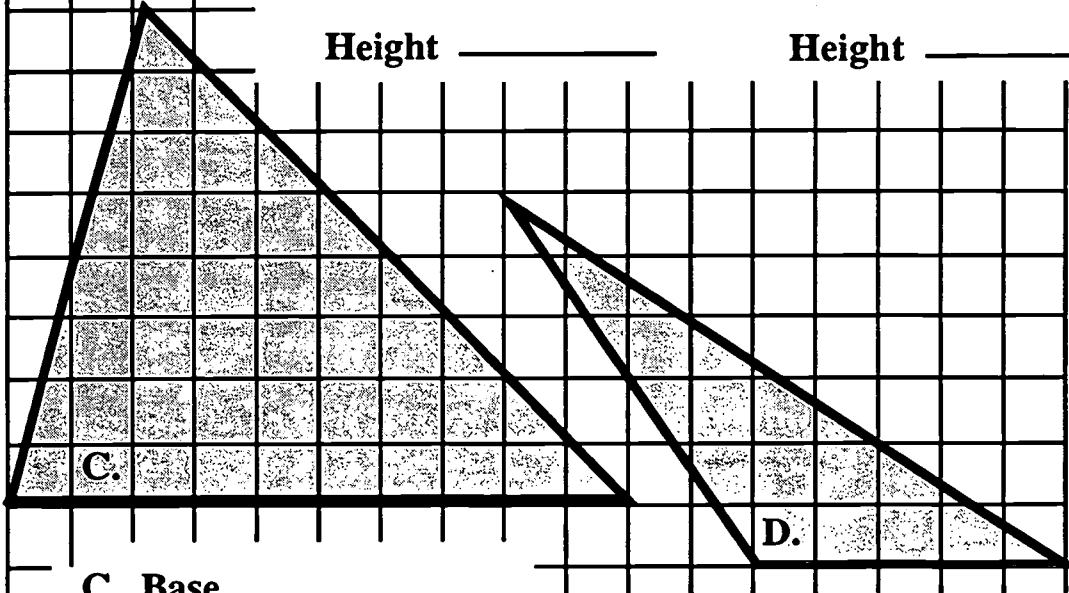

C. Base \_\_\_\_\_

D. Base \_\_\_\_\_

Height \_\_\_\_\_

Height \_\_\_\_\_

#17

# One-Half

Color Group \_\_\_\_\_

**One-half of 2 is 1.**

**One-half of 6 is 3.**

**One-half of 24 is 12.**

A. What is one-half of 4? \_\_\_\_\_

B. What is one-half of 8? \_\_\_\_\_

C. What is one-half of 40? \_\_\_\_\_

D. What is one-half of 22? \_\_\_\_\_

E. What is one-half of 64? \_\_\_\_\_

F. What is one-half of 36? \_\_\_\_\_

G. What is one-half of 50? \_\_\_\_\_

H. What is one-half of 72? \_\_\_\_\_

#18

## Triangle Areas

Color Group \_\_\_\_\_

You learned that the **area** of rectangle is found by multiplying the **length** by the **width**. The **length** of the rectangle below is 5 centimeters. The **width** of the rectangle is 4 centimeters. The **area** of the rectangle is 20 square centimeters.

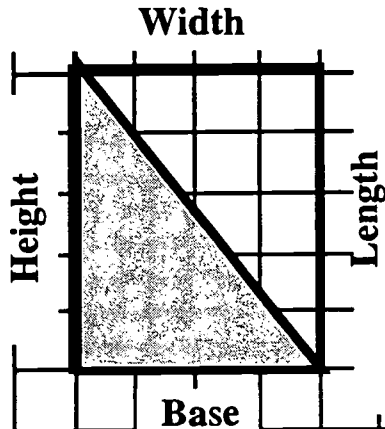

You learned that the **width** of a triangle is called the **base** and the **height** of a triangle is the distance straight up from the line where the base is to the top of the triangle.

The triangle at the left covers one-half of the rectangle. The **area** of this triangle is 10 square centimeters because one-half of 20 is 10.

The **area** of triangle is found by multiplying the **base** by the **height** and finding **one-half** of that answer.

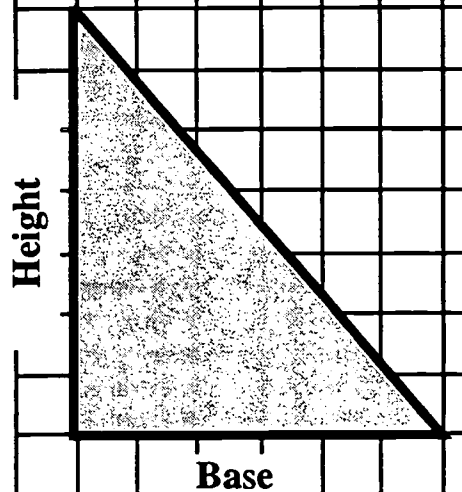

The **base** of this triangle is 6 cm.

The **height** of this triangle is 7 cm.

$$6 \times 7 = 42$$

**Area** = one half of (base x height)

**One-half** of 42 is 21

The **area** of the triangle is 21 sq. cm.

(Go to the next page)

#19A

# Triangle Areas

Color Group \_\_\_\_\_

Find the area of each of the triangles below.

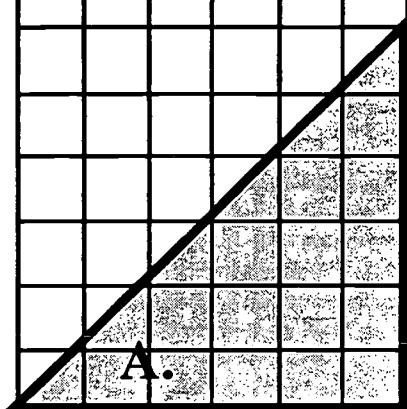

Base = \_\_\_\_\_

Height = \_\_\_\_\_

Base x Height = \_\_\_\_\_

One-half of Base x Height = \_\_\_\_\_

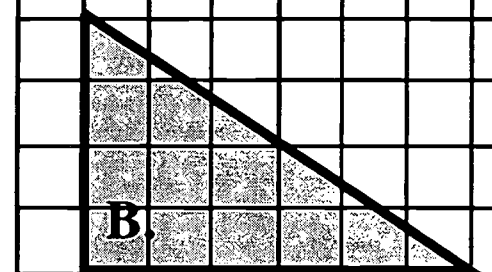

Base = \_\_\_\_\_

Height = \_\_\_\_\_

Base x Height = \_\_\_\_\_

One-half of Base x Height = \_\_\_\_\_

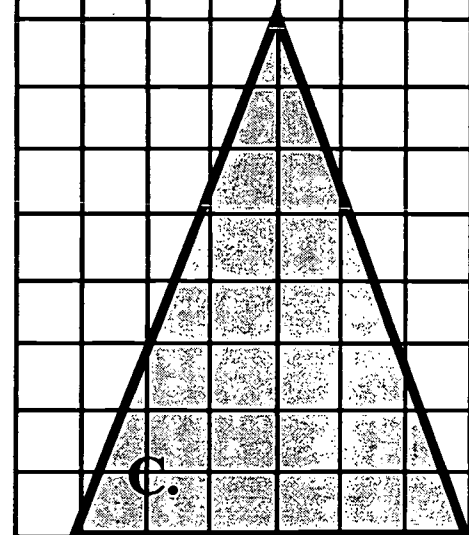

Base = \_\_\_\_\_

Height = \_\_\_\_\_

Base x Height = \_\_\_\_\_

One-half of Base x Height = \_\_\_\_\_

#19B

# More Triangle Areas

Color Group \_\_\_\_\_

Find the **area** of each of the triangles below.

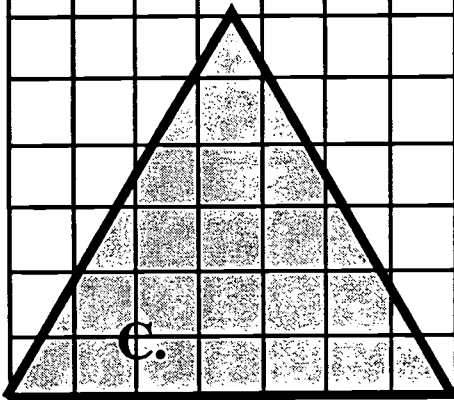
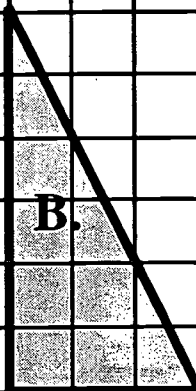
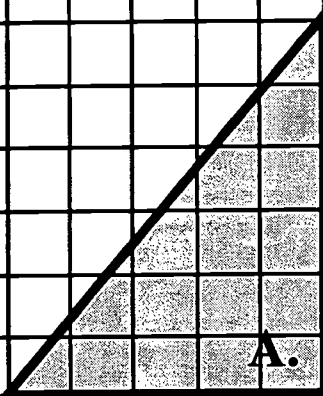

#20

## Estimating Circle Area

Color Group \_\_\_\_\_

The **area** of an object is the number of square units it covers. As you already learned, one way to find the **area** is to count the number of square units the object covers. Sometimes an object covers only part of a square unit. When this happens, you need to find another part of a square unit that is covered and count the two units as one.

These two sections add up to one full unit

These two sections add up to almost one full unit. So together they are counted as one unit.

Count how many squares the circle covers. Put a check in each square after you count it. If only part of a square is covered, find another part of a square and count the two parts as one full square.

Estimate \_\_\_\_\_

#21

# Practicing Circle Area

Color Group \_\_\_\_\_

Count how many squares the circles below cover. Put a check in each square after you count it. If only part of a square is covered, find another part of a square and count the two parts as one full square. Write what you think the **area** is on the lines below each circle.

A. \_\_\_\_\_ sq. units

B. \_\_\_\_\_ sq. units

C. \_\_\_\_\_ sq. units

#22

# Other Shape Areas

Color Group \_\_\_\_\_

Count how many squares the shapes below cover. Put a check in each square after you count it. If only part of a square is covered, find another part of a square and count the two parts as one full square. Write what you think the **area** is on the lines below each shape.

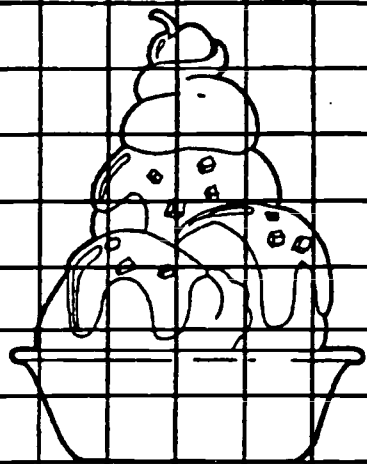
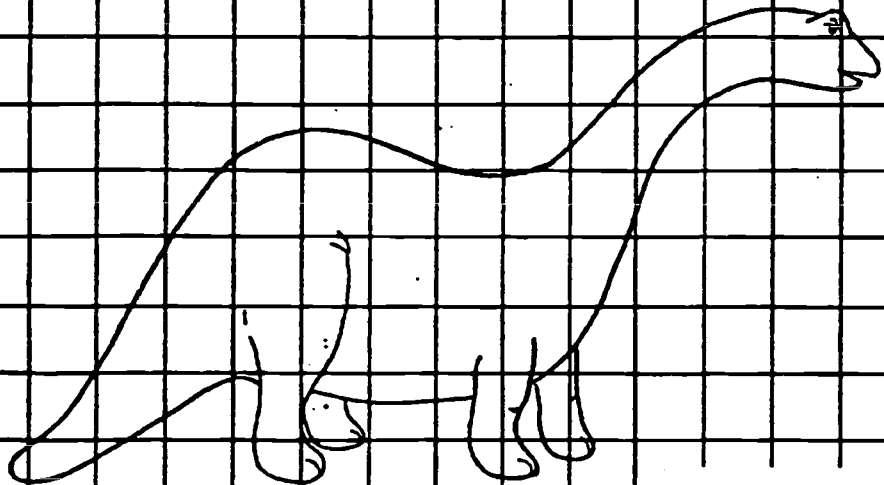
 <p><b>A.</b></p> <p>_____ sq. units</p>	 <p><b>B.</b></p> <p>_____ sq. units</p>
 <p><b>C.</b></p> <p>_____ sq. units</p>	



**Appendix F**  
**Science Curriculum Worksheets**



5. Rub the bag and the balloon with the cloth. Bring the balloon near the side of the bag. What happens to the rice?

---



---

5a. Why does this happen? \_\_\_\_\_

---

6. How did you create more static electricity?

---



---

Using the diagram, answer the following questions.

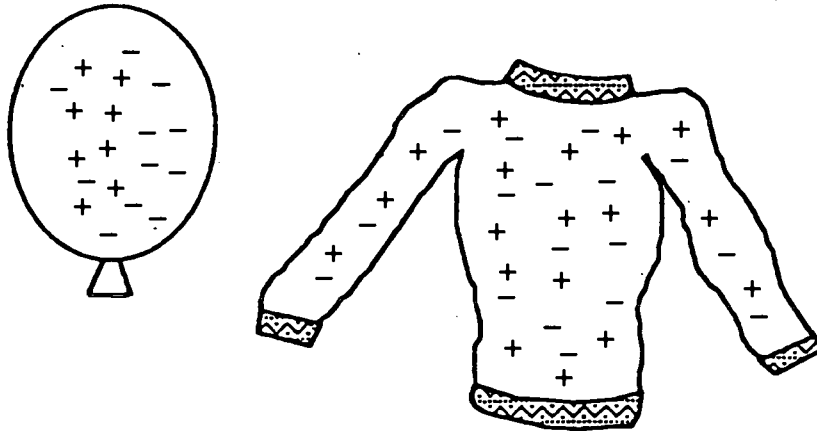

7. What can you tell us about this picture of the balloon and the sweater?

---



---

8. How did the balloon get the extra electrons? \_\_\_\_\_

---

## Current Electricity Teamsheet

Team Color: \_\_\_\_\_

**Conduct the following experiments by using the materials located in today's baggy bag. Use the space provided to record your observations.**

- Using **one battery** and **one wire**, try to light the bulb.

**Answer each question.**

Does the bulb have to be touching the battery?      **Yes No**

Does the wire have to be wrapped around the bulb? **Yes No**

Mark the two special places on the bulb that must be touched in order for it to light.



What locations on the battery have to be touched? Mark them with an X.



2. Using one battery, one wire, and the bulb, **draw many different ways** that your group can make the bulb light. You can use the masking tape to hold the wires in place.

3. Make connections using a **battery, bulb, and 2 wires**. Sketch the many connections which make the bulb light.

4. Look at each of the following pictures and decide if the bulb will light. Before you test the circuit, predict what you think may happen. Use "Yes" or "No" as your answer.

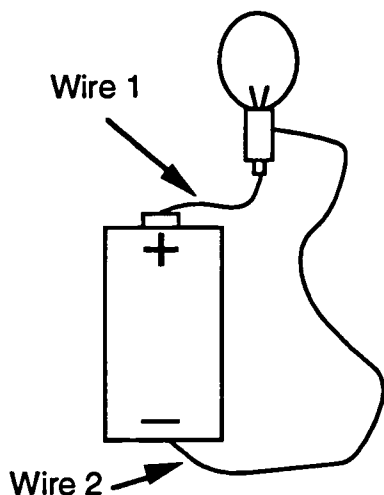

**Picture A**

Prediction #1 \_\_\_\_\_

Result \_\_\_\_\_

Remove  
Wire 2  
from  
the  
Battery

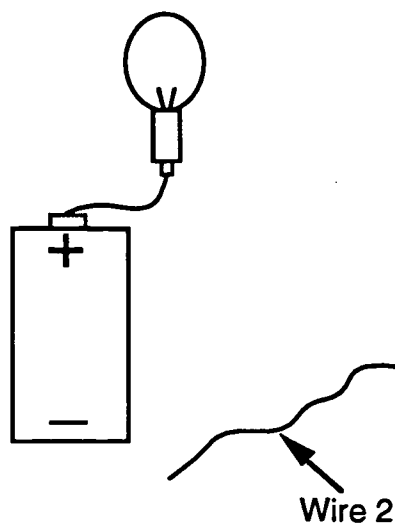

**Picture B**

Prediction #2 \_\_\_\_\_

Result \_\_\_\_\_

4a. Circle the picture A or B that shows the bulb lighting.

4b. Why didn't the bulb in the other picture light?

\_\_\_\_\_

4c. Which picture shows a complete circuit Picture A or Picture B?

\_\_\_\_\_

4d. Explain why a bulb does not light when the circuit is broken using the words **flow electrons, and protons**.

\_\_\_\_\_

\_\_\_\_\_

\_\_\_\_\_

\_\_\_\_\_

5. Identify which bulbs light and don't light by using the words **yes** and **no**.

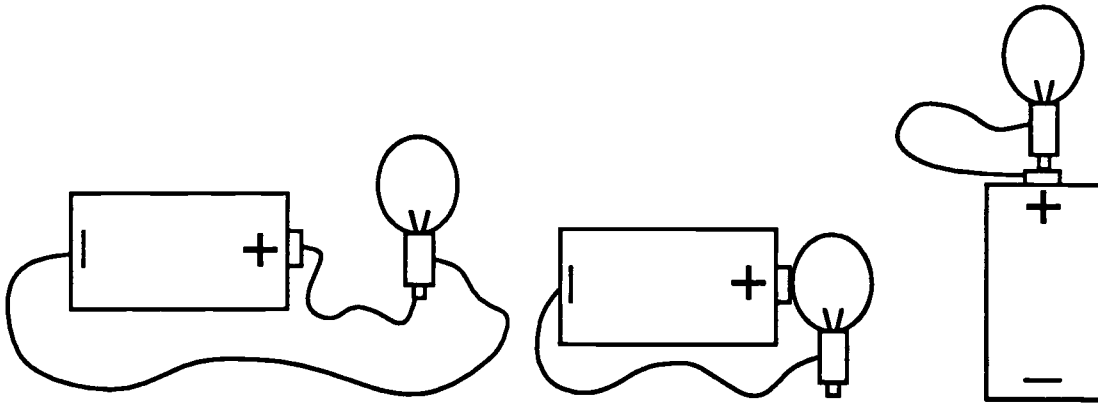

6. Using **two or more batteries**, light the bulb. Draw the picture that show the connections which make the bulbs light.

7. Light the bulb with **one** battery. Now light the bulb with **two** batteries. See the picture below.  
What happens to the bulb when you use two or more batteries?

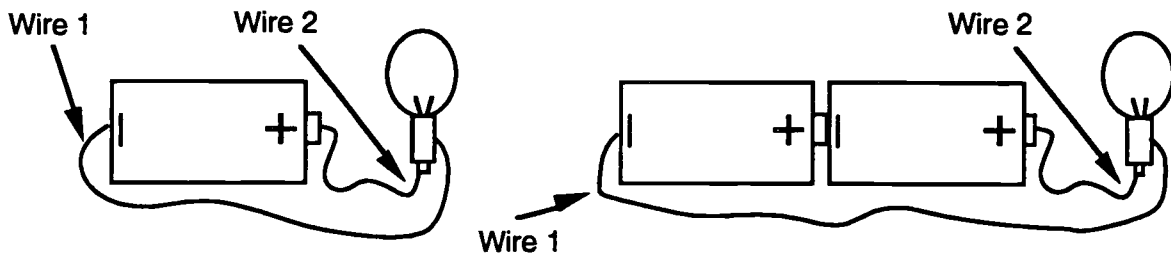

8. In this picture, the circuit is incomplete. This small gap will stop the current flow and the bulb will not light. Experiment with some of the materials in your baggy bag and see which object can be use to complete the circuit and light the bulb. The objects that help you to light the bulb are called conductors and the objects that don't help to light the bulb are called insulators. Use the chart to record your observations.

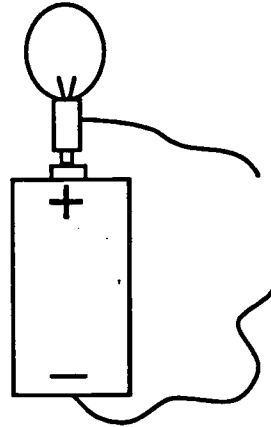

Conductor	Insulator

9. Look at your chart, what are all of the conductors made from?

---



---



10. Explain why conductors let a bulb light and insulators do not let a bulb light. Use the words: **Flow, electrons, circuit, conductors, and insulators.**

---

---

---

## Electromagnets Teamsheet

Team Color: \_\_\_\_\_

1. Use two wires to make the bulb light with one battery holder and the bulb holder. Draw lines where you put the two wires.

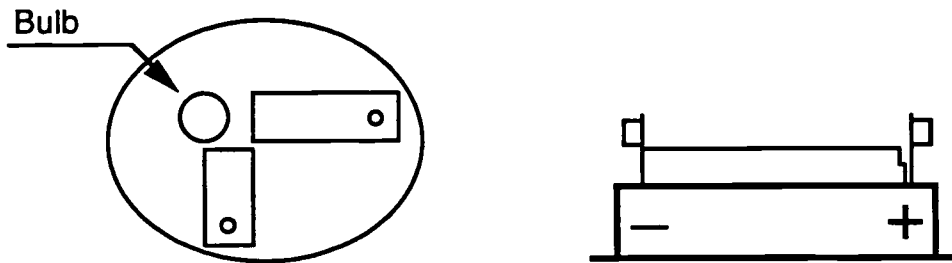

2. Now light the bulb using two batteries and the bulbholder. SEE THE PICTURE BELOW.

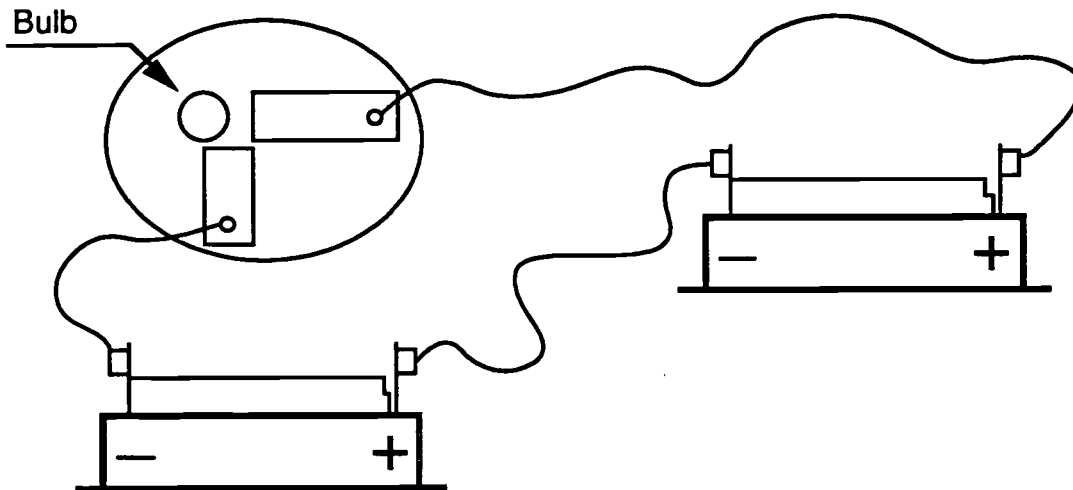

2a. Is the bulb brighter with one or two batteries?

---

2b. Why does this happen? Use the word POWER in your sentence.

---



---

3. **Without hooking up the nail to the battery,** take one of the nails and try to pick up some paperclips. What happens?

---

Remove the bulbholder from the battery holder.

4. Take the nail that is marked 20. Attach one wire from the nail to the battery holder. Attach the other wire from the nail to the other end of the battery holder. SEE THE PICTURE BELOW.

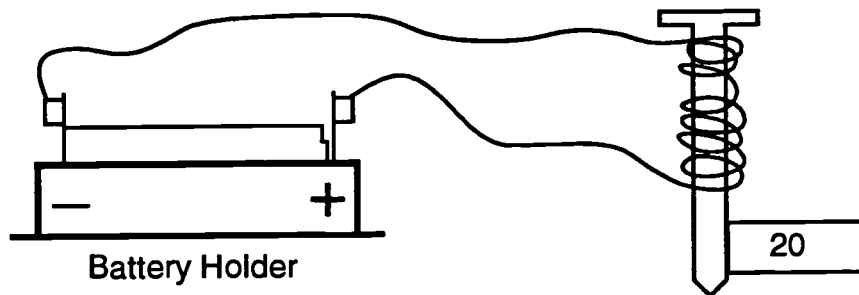

5. Now try to pick up some paperclips using the nail. How many paperclips does the nail pick up?

---

6. Now try to pick up some paperclips using the nail marked 40. How many paperclips does the nail pick up?

---

7. Which nail picks up the most paperclips? 20 or 40  
 7a. Why did this happen?
- 

8. Using two batteries and the nail marked 40, pick up some paperclips. SEE THE PICTURE BELOW.

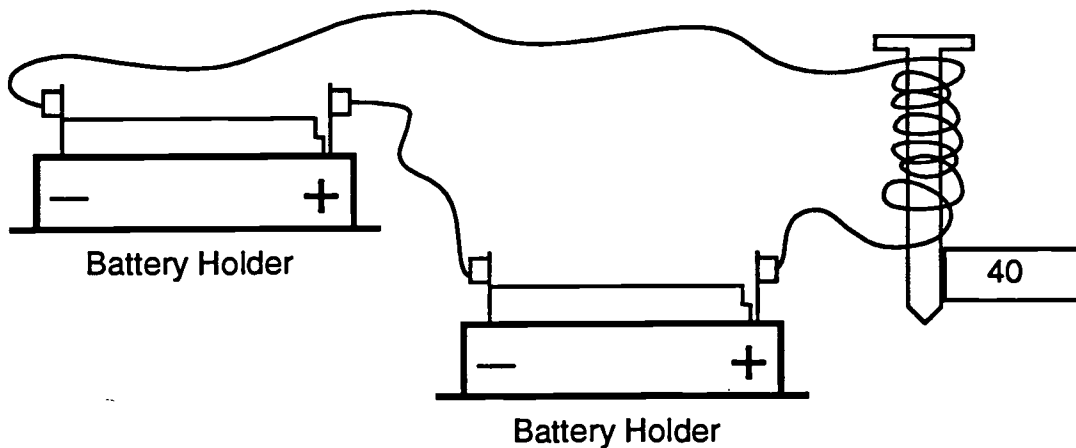

- 8a. How many paperclips does the nail pick up? \_\_\_\_\_
- 8b. Which magnet is stronger the one with two batteries or one battery?  
 One or Two (CIRCLE ONE)

9. What are the two things that make an electromagnet stronger?

---

---

10. Using the words ELECTRON FLOW and POWER explain why some magnets are stronger than others.

---

---

---

---

**Appendix G**  
**Electron Flow Circuit Handout**

## INSTRUCTIONAL POSTER

**About electric current**

An electric current is a drift of microscopic particles called electrons along a piece of wire. All substances contain electrons. They are part of the atoms of which everything is made. You, this book, and electronic components, are all made of atoms.

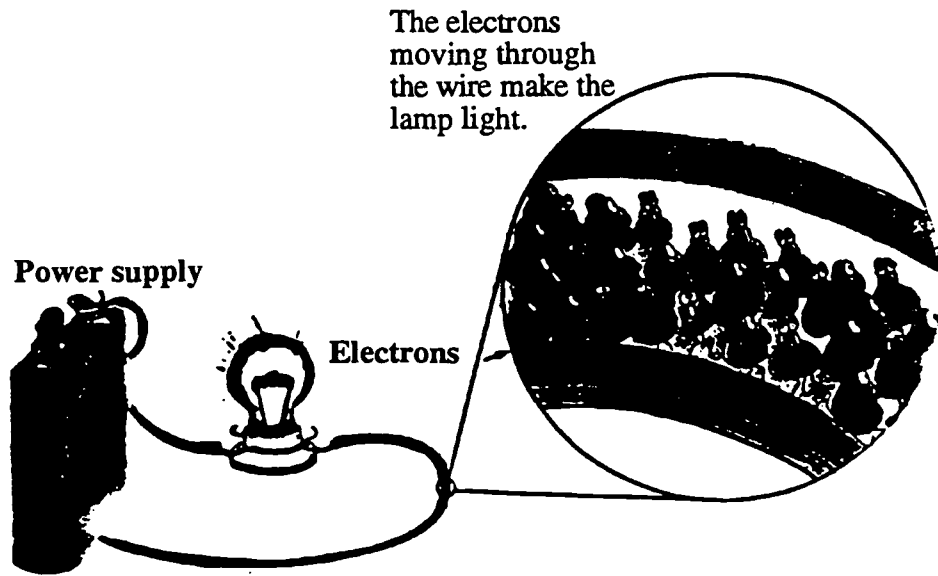

In certain substances, e.g., metal wire, electrons can be made to move easily by applying a power supply. Substances in which electrons move easily are called conductors.

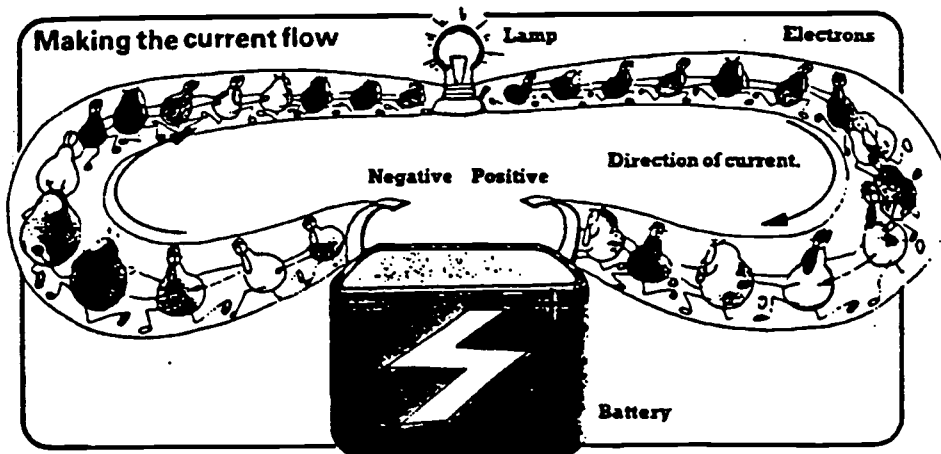

A battery is a power supply. It has two terminals. One terminal has a positive charge and the other has a negative charge. Electrons also have a negative charge. When wire is connected to each of the terminals, the electrons in the wire are repelled by the negative terminal and attracted to the positive. This causes the electrons to move through the wire and form an electric current.

---

## Research Monograph Series

The National Research Center on the Gifted and Talented

The University of Connecticut

362 Fairfield Road, U-7

Storrs, CT 06269-2007

### *Production Assistants*

Dawn R. Guenther

Siamak Vahidi

### *Reviewers*

Mallory Bagwell

Marcia Gentry

E. Jean Gubbins

Nancy B. Hertzog

Karen Kettle

James A. Kulik

Lori R. Maxfield

Sunghee Park

Jeanne Purcell

Michael C. Pyryt

Ann Robinson

### *Also of Interest*

Regular Classroom Practices With Gifted Students: Results of a National Survey of  
Classroom Teachers

*Francis X. Archambault, Jr., et al.*

An Observational Study of Instructional and Curricular Practices Used With Gifted and  
Talented Students in Regular Classrooms

*Karen L. Westberg, et al.*

Why Not Let High Ability Students Start School in January?

The Curriculum Compacting Study

*Sally M. Reis, et al.*



*Also of interest from the*  
**Research Monograph Series**

**Evaluation of the Effects of Programming Arrangements on Student Learning Outcomes**  
*Marcia A. B. Delcourt, et al.*

**Qualitative Extension of the Learning Outcomes Study**  
*Marcia A. B. Delcourt and Karen Evans*

**Toward a New Paradigm for Identifying Talent Potential**  
*Mary M. Frasier and A. Harry Passow*

**Talents in Two Places: Case Studies of High Ability Students With Learning Disabilities  
Who Have Achieved**  
*Sally M. Reis, Terry W. Neu, and Joan M. McGuire*

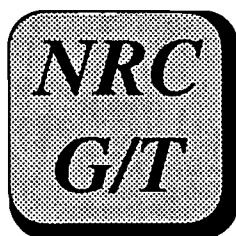

*The  
National  
Research  
Center  
on  
the  
Gifted  
and  
Talented  
Research  
Teams*

*The University of Connecticut*

Dr. Francis X. Archambault, Jr., Associate Director  
The University of Connecticut  
School of Education, U-4  
Storrs, CT 06269-2004  
860-486-4531

Dr. Alexinia Y. Baldwin  
Dr. Scott W. Brown  
Dr. Deborah E. Burns  
Dr. David A. Kenny  
Dr. Jonna Kulikowich  
Dr. Sally M. Reis  
Dr. Karen L. Westberg  
Dr. Michael F. Young

*The University of Georgia*

Dr. Mary M. Frasier, Associate Director  
The University of Georgia  
Department of Educational Psychology  
323 Aderhold Hall  
Athens, GA 30602-7146  
404-542-5106

Dr. Scott L. Hunsaker

*The University of Virginia*

Dr. Carolyn M. Callahan, Associate Director  
Curry School of Education  
The University of Virginia  
405 Emmet Street  
Charlottesville, VA 22903  
804-982-2849

Dr. Michael S. Caldwell  
Dr. Marcia A. B. Delcourt  
Dr. Brenda H. Loyd  
Dr. Kathleen May  
Dr. Claudia Sowa  
Dr. Ellen Tomchin  
Dr. Carol A. Tomlinson

*Yale University*

Dr. Robert J. Sternberg, Associate Director  
Department of Psychology  
Yale University  
P.O. Box 208205  
New Haven, CT 06520-8205  
203-432-4632

Dr. Pamela Clinkenbeard



U.S. DEPARTMENT OF EDUCATION  
Office of Educational Research and Improvement (OERI)  
Educational Resources Information Center (ERIC)



## NOTICE

### REPRODUCTION BASIS

This document is covered by a signed "Reproduction Release (Blanket)" form (on file within the ERIC system), encompassing all or classes of documents from its source organization and, therefore, does not require a "Specific Document" Release form.

This document is Federally-funded, or carries its own permission to reproduce, or is otherwise in the public domain and, therefore, may be reproduced by ERIC without a signed Reproduction Release form (either "Specific Document" or "Blanket").